

Variable Frequency Drive / Inverter **Starvert iS5**

0.75 - 55kW (1 - 75HP) 3 phase 200 - 230Volts
0.75 - 75kW (1 - 100HP) 3 phase 380 - 460Volts



Drive Solution





Contents

Overview	02
Features & Selection Guide	04
Specifications & Wiring	06
Terminal Configuration, Keypad & Parameter Navigation	08
Program Parameter Descriptions	10
Dimension	18
Options, DB Resistor & Peripheral Devices	20
RFI Filters	22



**Sensorless, sensored vector controlled iS5,
keeps your application in more stable,
durable and precise condition.**

Standard features

kW / Voltage Ratings:

- 0.75~55kW, 200-230VAC, 3 phase
- 0.75~75kW, 380-480VAC, 3 phase

Enclosure: IP00 ~ IP20

Inverter Type: PWM with IGBT

Control Method: Sensorless/Sensored Vector

1~15kHz Carrier Frequency (1~8kHz. over 30kW)

0~400Hz Output Frequency

Removable Keypad (Able to read & write parameters)

Intelligent Accel/Decel for Trip-Free Operation

Auto Tuning

8 Multi-Function Inputs

1 Multi-Function Outputs

Failure Relay

Built-in PID Control

Pre-Set Speeds

Wire Operation

Multi-step Programmable Run Patterns

Auto Torque Boost

DC Injection Braking

Stall Prevention

Built-In Braking Circuit for 0.75 ~ 7.5kW units

Options

Communications Board:

- RS-485
- DeviceNet
- F-Net
- ModBus-RTU
- ProfiBus DP
- Extended I/O Module

-Sub-A Board:

- 3 Multi-Function Input
- 3 Multi-Function Output

-Sub-B Board :

- Encoder Plus Input
- Encoder Plus Output

-Sub-C Board :

- 3 Multi-Function Input
- 3 Multi-Function Output

Aux. Analog Reference Frequency (Isolated)

Cable for Remote Keypad Operations

Dynamic Braking Units for 11~75kW Inverters

Dynamic Braking Resistors

Application

Traverse

Draw

MMC (Mult Motor Control)

Converting

Material Handling

Web Processing

Fan/Pump Controls

Conveyors

Industrial Washing machine, etc.

Conformity to global standards

UL and cUL listed for North America

CE marked for Europe

Quality process controlled by ISO9001, ISO14000



Extended I/O boards

The iS5 has several additional I/O boards that can be easily mounted into the connection terminal on control board. Each I/O board is standardized for a specific I/O requirement. The three main I/O boards are "Sub-board A", "Sub-board B" and "Sub-board C". This helps system engineer to design most adequate and cost effective system using the exactly necessary number of I/Os and functions. It is extendable and changeable in case of system upgrade or change. The control parameters and detailed functions for these boards are not shown until any of them is inserted.

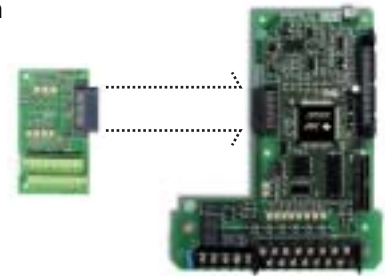

Diversity of communication interfaces

The iS5 provides most popular communication interfaces such as Device Net, Profibus DP, Modbus-RTU, RS485 and F-Net (LS proprietary protocol for LS PLC communication). The "Driveview™" software offers Window® based computer monitoring tool through RS-485 interface with graphic capture, keypad emulator, parameter edit, and text monitor. It is applicable for all LS inverters.

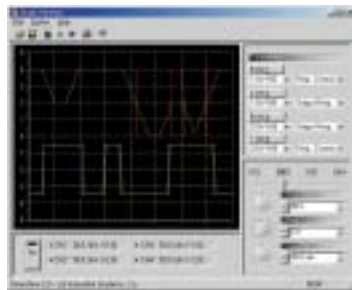

F-Net™
ModBus-RTU™
DeviceNet™
RS-485

Built-in PID control

It is valuable in process control. The built-in PID algorithm controls flow, temperature, pressure, etc. through the proportional, integral and differential calculus between the feedback value and reference value in closed loop. The high speed CPU makes the calculation easy and fast.

Sensorless vector control

The iS5 adopts sensorless vector control algorithm, and it improves not only the torque control characteristics, but the speed controllability in an uncertain condition caused by the load variation as well. The iS5 especially generates strong torque at a low speed range as shown below.

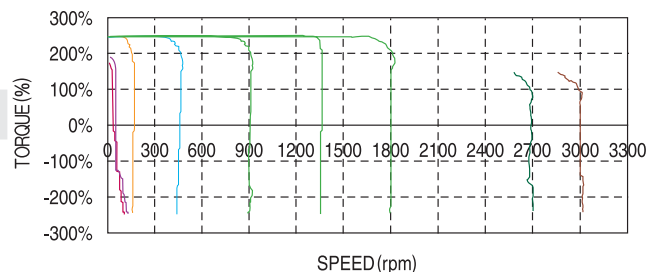
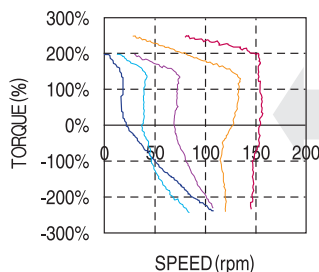

Auto tuning

The auto tuning algorithm in iS5 sets the motor factors automatically. It brings the traditional commissioning difficulties mainly in low speed by the load variation and the low torque generation to a settlement.

Optimum acceleration and deceleration

To make a maximum torque during the acceleration and deceleration, so called "trip free" function is acting during acceleration and deceleration. Both of Acceleration and deceleration may cause a trip in case that it is manually programmed. The 32-bit DSP CPU monitors the current transition during the acceleration and deceleration to program an optimum curve that is under the triptrigering level automatically.

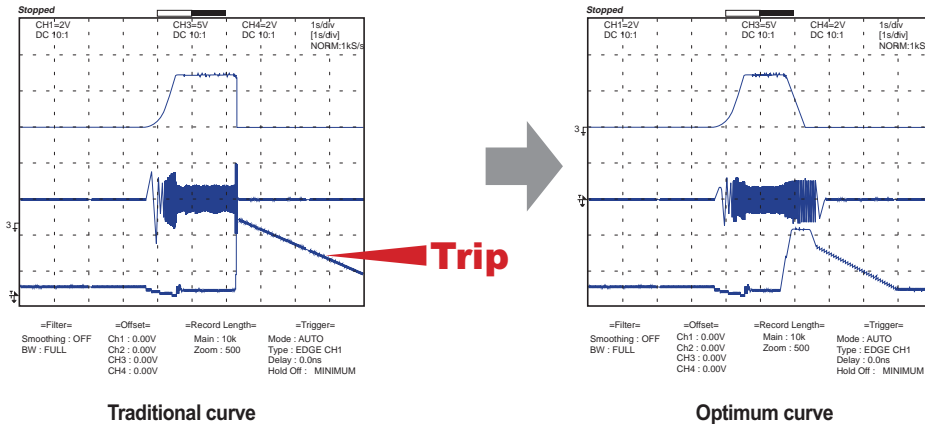

Inverter rating selection guide

Application motor			200~230V		380~460V	
KW	HP					
0.75	1	-----	SV008iS5-2	-----	SV008iS5-4	
1.5	2	-----	SV015iS5-2	-----	SV015iS5-4	
2.2	3	-----	SV022iS5-2	-----	SV022iS5-4	
3.7	5	-----	SV037iS5-2	-----	SV037iS5-4	
5.5	7.5	-----	SV055iS5-2	-----	SV055iS5-4	
7.5	10	-----	SV110iS5-2	-----	SV110iS5-4	
11	15	-----	SV150iS5-2	-----	SV150iS5-4	
15	20	-----	SV185iS5-2	-----	SV185iS5-4	
18.5	25	-----	SV220iS5-2	-----	SV220iS5-4	
22	30	-----	SV300iS5-2	-----	SV300iS5-4	
30	40	-----	SV370iS5-2	-----	SV370iS5-4	
37	50	-----	SV450iS5-2	-----	SV450iS5-4	
45	60	-----	SV550iS5-2	-----	SV550iS5-4	
55	75	-----		-----	SV750iS5-4	
75	100	-----		-----		

Inverter type nomenclature

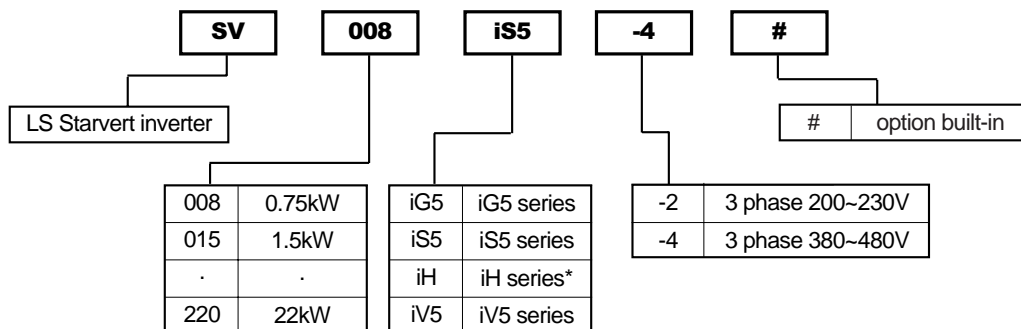

* iH inverter has a different designation in kW.

Specifications 200~230V Class (0.75~55kW)

Inverter Type (SV_ _iS5_)	008-2	015-2	022-2	037-2	055-2	075-2	110-2	150-2	185-2	220-2	300-2	370-2	450-2	550-2	
Motor Rating ^{*1)}	[HP]	1	2	3	5	7.5	10	15	20	25	30	40	50	60	75
	[kW]	0.75	1.5	2.2	3.7	5.5	7.5	11	15	18.5	22	30	37	45	55
Output ratings	Capacity[kVA] ^{*2)}	1.9	3	4.5	6.1	9.1	12.2	17.5	22.9	28.2	33.5	46	55	68	84
	FLA[A]	5	8	12	16	24	32	46	60	74	88	122	146	180	220
Input ratings	Frequency	0 ~ 400 Hz													
	Voltage	200 ~ 230V ^{*3)}													
Input ratings	Voltage	3 phase 200 ~ 230 V (± 10%)													
	Frequency	50 ~ 60 Hz (± 5%)													
Weight[kg]		4.6	4.6	4.8	4.9	7.5	7.7	13.8	14.3	19.4	20				

Specifications 380~480V Class (0.75~75kW)

Inverter Type (SV_ _iS5_)	008-4	015-4	022-4	037-4	055-4	075-4	110-4	150-4	185-4	220-4	300-4	370-4	450-4	550-4	750-4	
Motor Rating ^{*1)}	[HP]	1	2	3	5	7.5	10	15	20	25	30	40	50	60	75	100
	[kW]	0.75	1.5	2.2	3.7	5.5	7.5	11	15	18.5	22	30	37	45	55	75
Output ratings	Capacity[kVA] ^{*2)}	1.9	3	4.5	6.1	9.1	12.2	18.3	22.9	29.7	34.3	45	56	68	82	100
	FLA[A]	2.5	4	6	8	12	16	24	30	39	45	61	75	91	110	152
Input ratings	Frequency	0 ~ 400 Hz														
	Voltage	380 ~ 480V ^{*3)}														
Input ratings	Voltage	3 phase 380 ~ 480 V (± 10%)														
	Frequency	50 ~ 60 Hz (± 5%)														
Weight[kg]		4.6	4.6	4.8	4.9	7.5	7.7	13.8	14.3	19.4	20					

Braking Torque	Braking circuit	On board					Optional (Braking unit, resistor)					
	Average braking torque	100%					150%					
	Max.continuous braking	5seconds					Controlled by braking unit ^{*4)}					
	Max. duty	30 (3)%ED					10 %ED					
Cooling method	Forced air cooling								IP00			

*1) Indicates the maximum applicable capacity when using 4 pole LS standard motor.

*2) Rated capacity (3*V*1) is based on 220V for 200V class and 440V for 400V class.

*3) Maximum output voltage will not be greater than the input voltage. Output voltage less than the input voltage can be set.

*4) 0.75 ~ 3.7kW inverter have internal braking resistor inside. 5.5 ~ 75kW inverters need optional braking resistor.

Control	Control method	V/F control, sensorless vector control(selectable), sensored vector control		
	Frequency setting resolution	Digital reference : 0.01 Hz (below 100 Hz), 0.1 Hz (over 100 Hz)	Analog reference : 0.03 Hz / 50 Hz	
	Frequency accuracy	Digital : 0.01% of max. output frequency	Analog : 0.1% of max. output frequency	
	V/F ratio	Linear, Square pattern, User V/F		
	Overload capacity	150 % of rated current for 1 min., 200% of rated current for 0.5 sec. (characteristic is inversely proportional to time)		
	Torque boost	Manual torque boost (0 ~ 15 %), Auto torque boost		
Operation	Input signal	Operation method	Key / terminal / communication operation	
		Frequency setting	Analog : 0 ~ 10V / 4 ~ 20 mA / Additional port for Sub-board (0 ~10V)	
		Start signal	forward, reverse	
		Multi-step	Up to 8 speeds can be set (use multi-function terminal)	
		Multi-step accel/decel time	0 ~ 6,000 sec, up to 8 types can be set and selected for each setting (use the multi- function terminal), Accel/Decel pattern : linear pattern, U pattern, S pattern	
	Output signal	Emergency stop	Interrupts the output of the inverter	
		Jog	Jog operation	
		Auto operation	Operates from internal sequence by setting the multi-function terminal (5way x 8step) Trip status is removed when protective function is active	
		Fault reset	active	
		Indicator	Choose 1 from Output frequency, output current, output voltage, DC voltage (Output voltage: 0 ~ 10V)	
Protective function	Inverter trip	Overvoltage, undervoltage, overcurrent, fuse open, ground fault, inverter overheating, motor overheating, output phase loss, MC fail (over 30kW only), overload protection, external fault 1,2, communication error, loss of speed command, hardware fault, option fault etc.		
	Inverter alarm	Stall prevention, overload alarm		
	Momentary power loss	Less than 15 msec : continuous operation (over 30kW drives excluded), more than 15 msec : auto restart possible		
	Display Keypad	Operation information	Output frequency, output current, output voltage, frequency value setting, operating speed, DC voltage	
Environment	Trip information	Indicates the fault when the protection function activates, memorizes up to 5 faults		
	Ambient temperature	-10 °C ~ 40 °C		
	Storage temperature	-20 °C ~ 65 °C		
	Ambient humidity	90 % RH max.(Non condensing)		
	Altitude . Vibration	Below 1,000 m /below 5.9m/sec ² (=0.6g)		
Application side	No corrosive gas, combustible gas, oil mist, or dust			

Wiring

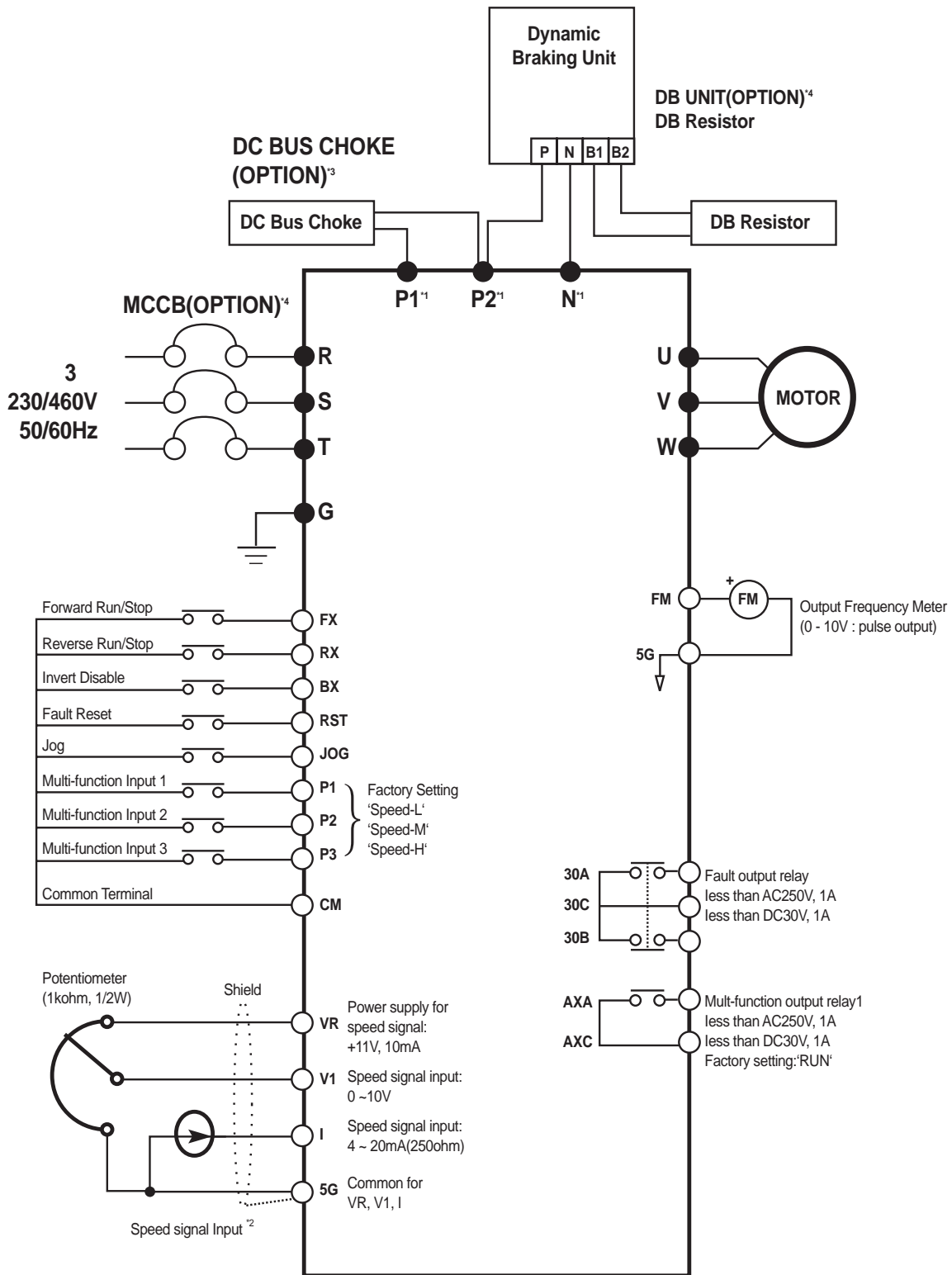

- Note) " " display main circuit terminals, " " display control circuit terminals.
- The terminal configuration varies depend on the model name.
 'P' terminal is available in 5.5 to 7.5kW inverters. 'P1' and 'P2' are available in 11 to 75kW inverters.
 'B1' and 'B2' terminals are for braking resistor or connection. 'P1' and 'P2' are for braking unit.
 - Analog speed command can be set by voltage, current and both of them.
 - When installing the DC Reactor, the common busbar between P1 and P2 must be removed.
 - 0.75 ~ 7.5kW inverters have on-board braking circuit. Braking resistor is only included for 0.75 ~ 3.7kW inverters.
 11 ~ 75kW inverters need optional braking unit and resistor for dynamic braking.
 - Marked as "CM" for over 30kW drives.

Power terminal configuration

Symbol	Function
R S T U V W	AC Line input (3 phase, 200-230 Vac for "-2" units and 380-480 Vac for "-4" units) 3 phase output terminals to motor
P	Positive DC Bus Terminals, DC Bus Choke (reactor)connection terminals. These terminals are available for 5.5 to 7.5kW inverter with optional DB unit when an application need braking torque over 30% ED
P1 P2	Positive DC Bus Terminals, DC Bus Choke (reactor)connection terminals. These terminals are available for 11 to 22kW inverter with optional DB unit. These terminal are shorted when DB unit is not applied.
B1 B2	Dynamic braking resistor connection terminals. These terminals are available for 0.75 to 3.7kW inverters in order to connect an external braking resistor.
N	Negative DC Bus terminal
G	Chassis ground (The ground terminal ("G") may be located on heat sink instead of terminal strip depend on the model type)

Control terminal configuration

Type	Symbol	Name	Description	
Input signal	Starting Function Selection	P1, P2, P3	Multi function input 1,2,3 Used for multi function input. Factory default is set to step frequency 1, 2, 3.	
		FX	Forward run command Forward run when closed and stop when open.	
		RX	Reverse run command Reverse run when closed and stop when open.	
		JOG	Jog frequency reference Runs at jog frequency when the jog signal is ON. The direction is set by the FX (or BX) signal.	
		BX	Emergency stop When the BX signal is ON, the output of the inverter is cut off. When the motor uses an electrical brake to stop, BX is used to cut off the output signal. When the BX signal, which does not cut off by latching, is OFF and the FX signal (or the RX signal) is ON, the motor keeps running, so be cautious.	
		RST	Fault reset Used to release the protective status when the protective circuit is active.	
	Analog/Digital		CM	Sequence common Used for the common terminal for contact input terminals.
			NC	- Not used.
			VR	Frequency setting power (+12V) Used as power for the analog frequency setting. Maximum output is +12V, 100mA.
			V1	Frequency reference (Voltage) Used for frequency reference and uses 0-10V for input. Input resistance is 20 kΩ
		I	Frequency reference (Current) Used for frequency reference and uses DC 4-20mA for input. Input resistance is 250Ω	
		5G	Frequency setting common terminal Common terminal for the analog frequency reference signal and the FM (for monitoring).	
Output signal	Pulse	FM	Analog/digital output (For external monitoring) Outputs one of the followings: output frequency, output current, output voltage, DC link voltage. Factory default is set to output frequency. Maximum output voltage and output current is 0-12V, 1mA. Output frequency is set to 500Hz.	
	Contact	30A,30C,30B	Fault contact output Activates when the protective function is operating. AC250V 1A or less, DC30V 1A or less Fault : 30A-30C short (30B-30C open) Normal : 30B-30C short (30A-30C open)	
		AXA,AXC	Multi-function output Use after defining the multi-function output terminal. AC250V 1A or less, DC30V 1A or less.	
Comm.	RS232	CN3	Communication port Use the keypad connector. Use the keypad connector for RS232 communication. Disconnect the keypad and connect the RS232-RS485 converter for RS485 communication.	

Keypad

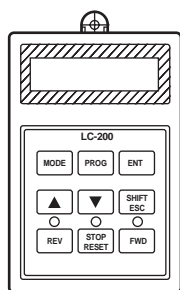

1. LCD Keypad

Key/LED	Name	Description
MODE	Mode key	The mode button moves you through the seven program groups : DRV, FUN1, FUN2, I/O, (EXT), (COM) and APP.
PROG	Program key	The program button is used to go into programming mode to change data.
ENT	Enter key	The enter button is used to enter changed parameters.
UP	Up key	The up and down arrows are used to move through and change data.
DOWN	Down key	
SHIFT/ESC	Shift key	The button is used to move cursor across the display in a programming mode.
	Escape key	This button is used to move the program code to DRV00 from any program code.
REW	Reverse key	The reverse run button is used to run the motor in reverse direction.
STOP/RESET	Stop key	The stop button is used to the drive from running.
	Reset key	The reset button is used to reset faults.
FWD	Forward key	The forward run button is used to run the motor in forward direction.
STOP/RESET	Reverse run	The LED blinks when th inverter accels or decels.
	Stop/reset	The LED blinks when there is a fault.
FWD	Forward run	The LED blinks when the inverter accels or decels.

2. LED Keypad (7-segment)

Encoder knob	Encoder Knob	This is used to move you through seven parameter groups and parameter codes. Also, used to change data by rotating knob.
SET	Set key	This is used to go into program mode to change data and to enter the changed data.
SHIFT/ESC	Shift key	This is used to go into program mode to change data and to enter the changed data.
	Escape key	This button is used to move cursor across the display in a programming mode.
STOP/RESET	Stop key	This is used to stop the inverter from running. The reset button is used to reset faults.
	Reset key	This is used to run the inverter.
RUN	Run key	The motor direction is set in DRV13.
SET	Setting status	It blinks in setting mode.
STOP/RESET	Stop/Fault status	The LED is lit in Stop status and blinks in fault status.
	Run status	The LED is lit in Run status and blinks in fault status.
DRV	Drive group	It blinks in drive group.
FU1	Function1 group	It blinks in Function1 group.
FU2	Function2 group	It blinks in Function2 group.
I/O	I/O group	It blinks in I/O group.
EXT	Sub-board group	It blinks in Sub-board group.
I/O+EXT	Option-board group	It blinks in Option board group.
I/O+EXT+FU2	Application group	It blinks in Application group.

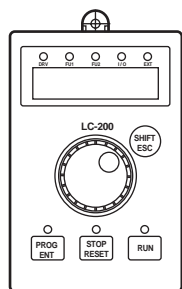

Parameter group

Parameter group	LCD keypad	7-segment keypad	Description
Drive	DRV	DRV LED is lit	Command frequency, accel/decel time, etc. Basic parameters.
Function 1	FU1	FU1 is lit	Max. frequency, amount of torque boost, etc. Basic function related parameters.
Function 2	FUN2	FU2 is lit	Frequency jumps, max./min. limit of frequency etc. Application function related parameters.
Input / Output	I/O	I/O is lit	Multi function terminal setting, auto operation etc. Parameter needed for sequence operation.
External board	EXT	EXT is lit	Displayed when sub-board is installed.
Communication	COM	I/O + EXT are lit	Displayed when option board is installed.
Application	APP	I/O + EXT + FU2 are lit	Specific application related parameters.

Parameter navigation

1. LCD Keypad

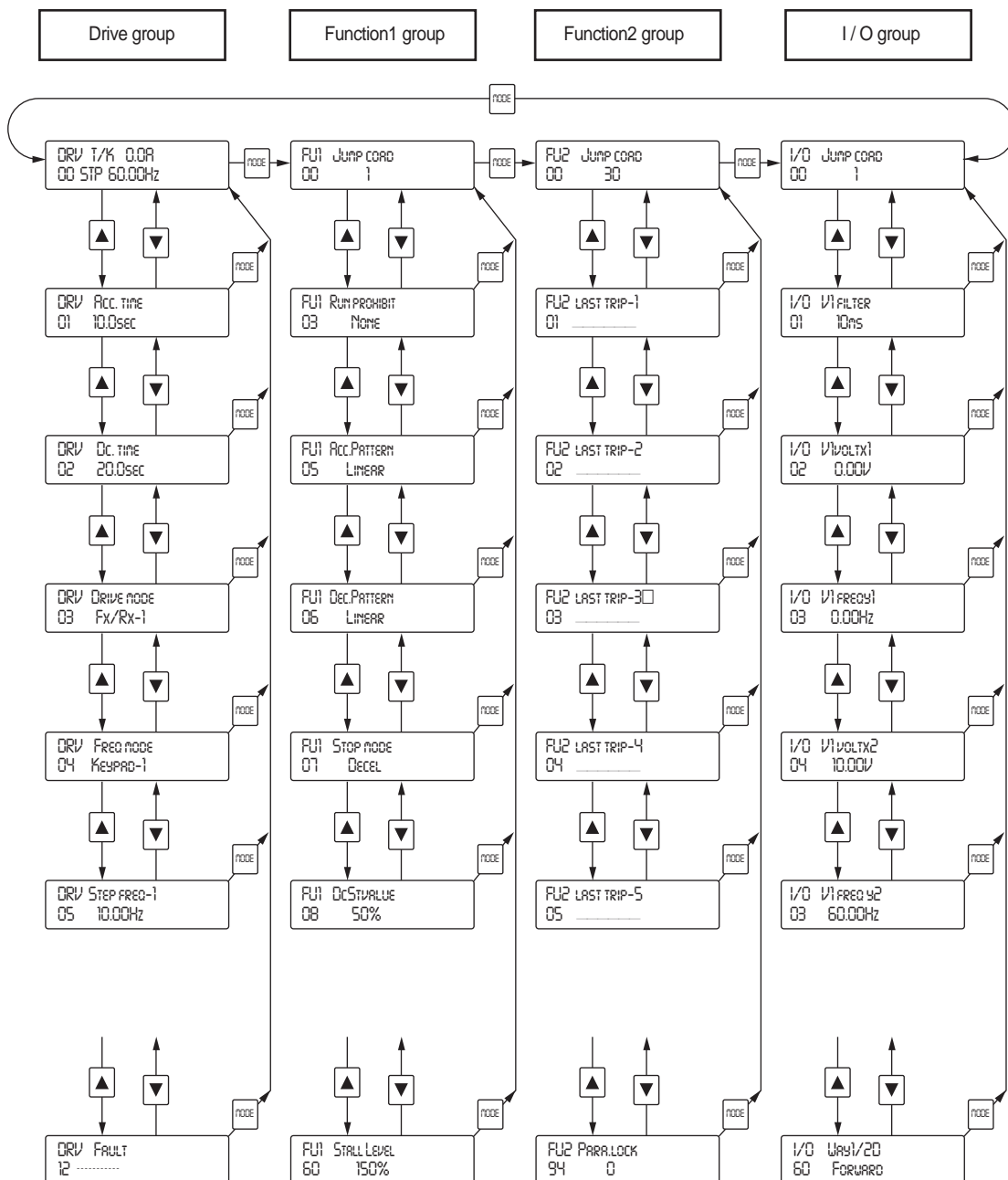

2. LED keypad (7-segment)

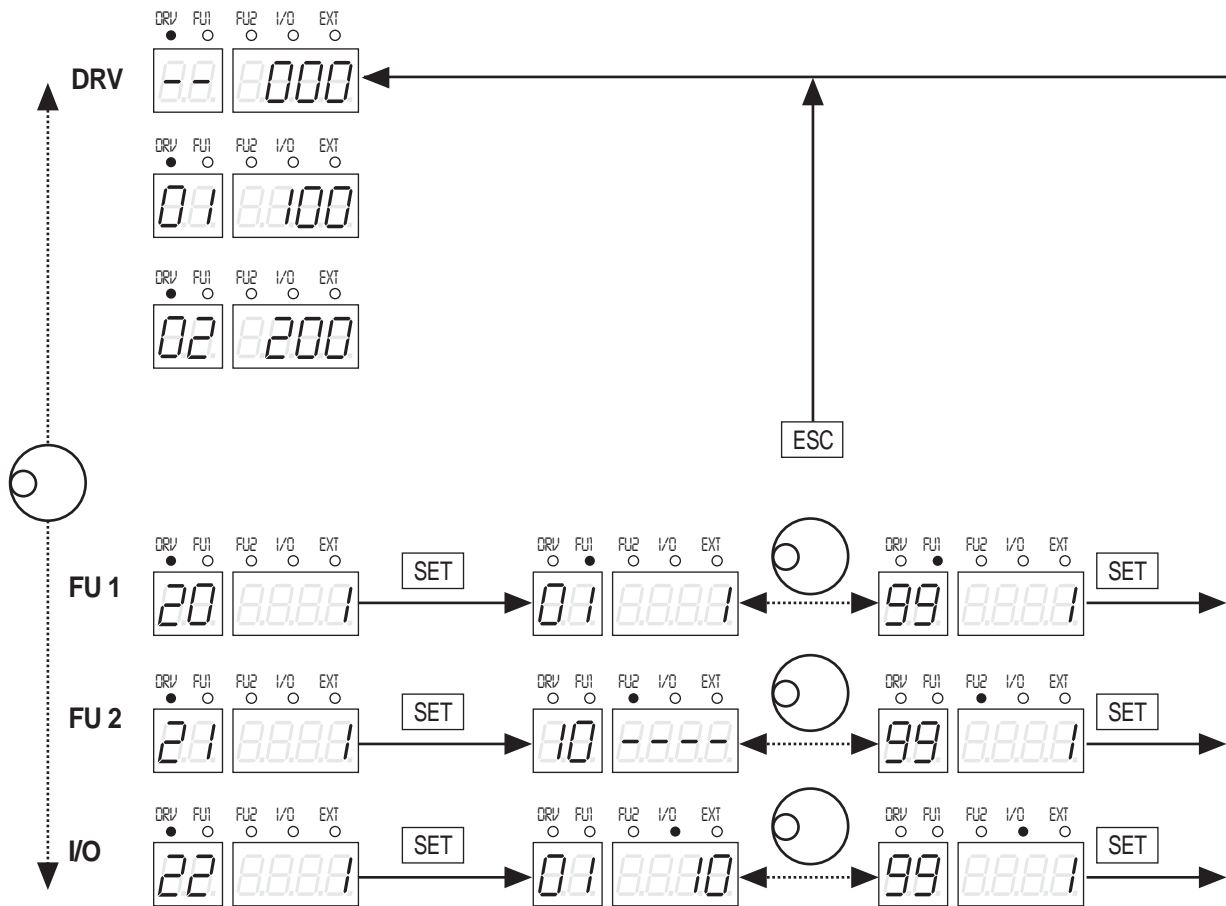

Operation method

Operation method	Function	Function setting
Keypad	Run/Stop command and frequency are set only through the keypad. Closing FX or RX terminal performs Run/Stop. Frequency reference is set through keypad	DRV 03 : Keypad DRV 04 : Keypad
Terminal	Run/Stop command and frequency are set only through the terminal. Closing FX or RX terminal performs Run/Stop. Frequency reference is set through V1 or I or V1+I terminal.	DRV 03 : Fx/Rx-1 or -2 DRV 04 : V1 or I or V1+I DRV 03 : Keypad-1 or -2 DRV 04 : V1 or I or V1+I
Keypad and Terminal	Closing Fx or RX terminal performs Run/Stop. Frequency reference is set through keypad.	DRV 03 : Fx/Rx-1 or -2 DRV 04 : Keypad-1 or -2
Option board	Operation using additional sub or option board. Sub board : SUB-A, SUB B, .. SUB-H Option board : Device Net, Synchro, Profibus DP, Digital-in, RS485, Modbus-RTU	

Program parameter descriptions

1. Drive Group [DRV]

Code	Description	Keypad Display		Setting Range		Units	Factory Default	Adjustable during run
		LCD	7-segment	LCD	7-segment			
DRV-00	Output Frequency or Reference Frequency. Output Current (LCD)	Cmd.freq	F or r (DRV-13)	0 to FU1-20 (Max.freq)		0.01	0.00 [Hz]	Yes
DRV-01	Acceleration Time	Acc.time	01	0 to 6000		0.1	10.0 [sec]	Yes
DRV-02	Deceleration Time	Dec.time	02	0 to 6000		0.1	20.0 [sec]	Yes
DRV-03	Drive Mode (Run/Stop method)	Drive mode	03	Keypad Fx/Rx-1 Fx/Rx-2	0 1 2	1	1 (Fx/Rx-1)	No
DRV-04	Frequency Mode (Freq. setting method)	Freq mode	04	Keypad-1 Keypad-2 V1 1 V1+1	0 1 2 3 4	1	0 (keypad-1)	No
DRV-05	Step Frequency 1	Step freq-1	05	FU1-22 to Fu1-20		0.01	10.00 [Hz]	Yes
DRV-06	Step Frequency 2	Step freq-2	06	(Starting freq to Max. freq)		-	20.00 [Hz]	-
DRV-07	Step Frequency 3	Step freq-3	07	The load current in RMS		-	30.00 [Hz]	-
DRV-08	Output Current	Current	08	The motor speed in rpm		-	# [A]	-
DRV-09	Motor Speed	Speed	09	The DC link voltage inside inverter		-	# [rpm]	-
DRV-10	DC link Voltage	DC link Vtg	10	Selected in FU-73 (User disp)		-	# [V]	-
DRV-11	User Display selection	User disp	11	-		-	-	Yes
DRV-12	Fault Display	Fault	12	Not available	0 [Forward] 1 [reverse]	-	None nOn	-
DRV-13	Motor Direction set	Not displayed	13			-	0	-
DRV-14	Command/output frequency	Tar/Out Freq.	14	Command/output frequency		-	# [Hz]	Yes
DRV-15	Command/feedback frequency	Ref/Fdb Freq.	15	Command/feedback frequency		-	# [Hz]	Yes
DRV-20	FU1 Group selection	Not displayed	20	Not available	Press	-	1	Yes
DRV-21	FU2 Group selection		21		[Prog/ENT] key	-	1	Yes
DRV-22	I/O Group selection		22			-	1	Yes
DRV-23	EXT Group selection		23			-	1	Yes
DRV-24	COM Group selection		24			-	1	Yes
DRV-25	APP Group selection		25			-	1	Yes

2. Function 1 Group [FU1]

FU1-00	aJump to desired code #	Jump code	Not displayed	1 to 99	Not available	1	1	Yes
FU1-03	Run Prevention	Run Prev.	3	None Forward Prve Reverse Prve	0 1 2	1	0 (None)	No
FU1-05	Acceleration Pattern	Acc.pattern	5	Liner S-curve U-curve Minimum Optimum	0 1 2 3 4	1	0 (Liner)	No
FU1-06	Deceleration Pattern	Dec.pattern	6	Liner S-curve U-curve Minimum Optimum	0 1 2 3 4	1	0 (Liner)	No
FU1-07 [1]	Stop Mode	Stop mode	7	Decel DC-brake Free-run	0 1 2	1	0 (Decel)	No
FU1-08	DC Injection Braking Frequency	DCBr freq	8	FU1-22 to 60 [Hz]		0.01	5.00 [Hz]	No
FU1-09	DC Injection Braking On-delay	DCBlk time	9	0 to 60 [sec]		0.01	0.1 [sec]	No
FU1-10	DC Injection Braking Voltage	Dcbr value	10	0 to 200 [sec]		1	50 [%]	No
FU1-11	DC Injection Braking Time	DcBr time	11	0 to 60 [sec]		0.1	1.0 [sec]	No
FU1-12	StartingDC Injection Braking Voltage	DcSt value	12	0 to 200 [sec]		1	50 [%]	No
FU1-13	StartingDC Injection Braking Time	DcSt time	13	0 to 60 [sec]		0.1	0.0 [sec]	No
FU1-20	Maximum Frequency	Max freq	20	40 to 400[Hz]		0.01	60.00 [Hz]	No
FU1-21	Base Frequency	Base freq	21	30 to FU1-20		0.01	60.00 [Hz]	No
FU1-22	Starting Frequency	Start freq	22	0.01 to 10[Hz]		0.01	0.50 [Hz]	No
FU123 [2]	Frequency Limit selection	Freq limit	23	No Yes	0 1	1	0 (No)	No
FU1-24	Low Limit Frequency	F-limit Lo	24	FU1-22 to Fu1-25		0.01	0.50[Hz]	No
FU1-25	High Limit Frequency	F-limit Hi	25	FU1-22 to Fu1-25		0.01	60.00[Hz]	No
FU1-26	Manual/Auto Torque Boost selection	Torque booth	26	Manual Auto	0 1	1	0 (Manual)	No
FU1-27	Torque Boost in Forward Direction	Fwd booth	27	0 to 15 [%]		0.01	2.0 [%]	No
FU1-28	Torque Boost in Reverse Direction	Rev booth	28	0 to 15 [%]		1	2.0 [%]	No
FU1-29 [3]	Volts/Hz Pattern	V/F pattern	29	Linear Square User V/F	0 1 2	0.01	0 (Linear)	No
FU1-30	User V/F - Frequency 1	User freq 1	30	0 to FU1-20		0.01	15 [Hz]	No
FU1-31	User V/F - Voltage 1	User volt 1	31	0 to 100 [%]		1	25 [%]	No
FU1-32	User V/F - Frequency 2	User freq 2	32	0 to FU1-20		0.01	30.00 [Hz]	No
FU1-33	User V/F - Voltage 2	User volt 2	33	0 to 100 [%]		1	50 [%]	No
FU1-34	User V/F - Frequency 3	User freq 3	34	0 to FU1-20			45 [Hz]	No
FU1-35	User V/F - Voltage 3	User volt 3	35	0 to 100 [%]			75 [%]	No
FU1-36	User V/F - Frequency 4	User freq 4	36	0 to FU1-20			60.00 [Hz]	No
FU1-37	User V/F - Voltage 4	User volt 4	37	0 to 100 [%]			100 [%]	No
FU1-38	Output Voltage Adjustment	Volt control	38	40 to 110.0 [%]			100.0 [%]	No
FU1-39	Energy Save Level F39	Energy save	39	0 to 30 [%]			0 [%]	Yes
FU150 [4]	Electronic Thermal selection	ETH select	50	No Yes	0 1		0 (No)	Yes

2. Function 1 Group [FU1]

Code	Description	Keypad Display		Setting Range		Units	Factory Default	Adjustable during run
		LCD	7-segment	LCD	7-segment			
FU1-51	Electronic Thermal Level for 1 minute	ETH 1min	5 1	FU1-52 to 200 [%]		1	150 [%]	Yes
FU1-52	Electronic Thermal Level for continuous	ETH cont	52	50 to FU1-51		1	100 [%]	Yes
FU1-53	Electronic Thermal Characteristic selection	Motor type	53	self-cool	0	1	0 (self-cool)	Yes
FU1-54	(Motor type)			Forced-coo	1			
FU1-55	Overload Warning Level	OL level	54	30 to 150 [%]		1	150 [%]	Yes
FU1-56	Overload Warning Hold Time	OL time	55	0 to 30 [sec]		0.1	10.0 [sec]	Yes
	Overload Trip selection	OLT select	56	No	0	1	1 (Yes)	Yes
FU1-57				Yes	1			
FU1-58	Overload Trip Level	OLT level	57	30 to 150 [%]		1	180 [%]	Yes
FU1-59	Overload Trip Delay Time	OLT time	58	0 to 60 [sec]		1	60.0 [sec]	Yes
FU1-60	Stall Prevention Mode selection	Stall prev.	59	000 to 111 (bit set)		bit	000	No
FU1-99	Stall Prevention Level	Stall level	60	30 to 150 [%]		1	150 [%]	No
	Return Code	Not display	99	Not available	[PROG/ENT] or [SHIFT/ESC]	1	1	Yes

3. Function 2Group [FU2]

Code	Description	Keypad Display		Setting Range		Units	Factory Default	Adjustable during run
		LCD	7-segment	LCD	7-segment			
FU2-00	Jump to desired code #	Jump code	Not displayed	1 to 99	Not available	1	30	Yes
FU2-01	Previous Fault History 1	Last trip-1	1				0 (None)	
FU2-02	Previous Fault History 2	Last trip-2	2					
FU2-03	Previous Fault History 3	Last trip-3	3					
FU2-04	Previous Fault History 4	Last trip-4	4					
FU2-05	Previous Fault History 5	Last trip-5	5					
FU2-06	Erase Fault History	Erase trips	6	No	0	1	0 (No)	Yes
				Yes	1			
FU2-07	Dwell Frequency	Dwell freq	7	FU1-22 to FU1-20		0.01	5.00 [Hz]	No
				(starting freq.to Max.freq.)				
FU2-08	Dwell Time	Dwell time	8	0 to 10 [sec]		0.1	0.0 [sec]	No
FU2-10[5]	Frequency Jump selection	Jump Freq	10	No	0	1	0 (No)	No
				Yes	1			
FU2-11	Jump Frequency 1 Low	Jump lo 1	1 1	Fu1-22 to FU2-12		0.01	10.00 [Hz]	No
FU2-12	Jump Frequency 1 High	Jump Hi 1	1 2	Fu1-11 to FU2-20		0.01	15.00 [Hz]	No
FU2-13	Jump Frequency 2 Low	Jump lo 2	1 3	Fu1-22 to FU2-14		0.01	20.00 [Hz]	No
FU2-14	Jump Frequency 2 High	Jump Hi 2	1 4	Fu1-13 to FU2-20		0.01	25.00 [Hz]	No
FU2-15	Jump Frequency 3 Low	Jump lo 3	1 5	Fu1-22 to FU2-16		0.01	30.00 [Hz]	No
FU2-16	Jump Frequency 3 High	Jump Hi 3	1 6	Fu1-15 to FU2-20		0.01	35.00 [Hz]	No
FU2-17	Starting rate of S curve	Start Curve	1 9	0 - 100 [%]		1	40 [%]	No
FU2-18	Ending rate of curve	End curve	1 9	0 - 100 [%]		1	40 [%]	No
FU2-19	Input/Output Phase Loss Protection	Trip select	1 9	00 to 11 (bit set)		-	00	Yes
FU2-20	Power ON Start selection	Power-on run	20	No	0	1	0 (No)	Yes
				Yes	1			
FU2-21	Restart after Fault Reset	RST restart	2 1	No	0		0 (No)	Yes
				Yes	1			
FU2-22	Speed Search selection	Speed Search	22	0000 to 1111 (bit set)		-	0000	No
FU2-23	Current Limit Level during Speed Search	SS Sup-Curr	23	80 to 200 [%]		1	100 [%]	Yes
FU2-24	P Gain during Speed Search	SS P-gain	24	0 to 30000		1	100	Yes
FU2-25	I Gain during speed search	SS I-gain/Retry	25	0 to 30000		1	1000	Yes
FU2-26	Number of Auto Restart Attempt	number	26	0 to 10		1	0	Yes
FU2-27	Delay Time before Auto Restart	Retry Delay	27	0 to 60 [sec]		0.1	1.0 [sec]	Yes
FU2-30	Rated Motor selection	Motor select	30	0.75kW	0	1	[6]	No
				1.5kW	1			
				2.2kW	2			
				3.7kW	3			
				5.5kW	4			
				7.5kW	5			
				11.0kW	6			
				15.0kW	7			
				18.5kW	8			
				22.0kW	9			
				30kW	10			
				37kW	11			
				45kW	12			
				55kW	13			
				75kW	14			
FU2-31	Number of Motor Pole	Pole number	3 1	2 to 12		1	4	No
FU2-32	Rated Motor Slip	Rated-Slip	32	0 to 10 [Hz]		0.01	[7]	No
FU2-33	Rated Motor Current in RMS	Rated-Curr	33	1 to 200 [A]		1		No
FU2-34	No Load Motor Current in RMS	Noload-	34	0.5 to 200 [A]		1		No
FU2-36	Motor Efficiency	CurrEfficiency	36	70 to 100 [%]		1		No
FU2-37	Load Inertia	Inertia rate	37	0 to 1		1	0	No
FU2-38	Carrier Frequency	Carrier freq	38	[8] 1 to 15 [kHz]		1	5 [kHz]	Yes
FU2-39	Control Mode selection	Control mode	40	V/F	0	1	0 [V/F]	No
				Slip comp	1			
				PID	2			
				Sensorless	3			
FU2-40	Auto tuning selection	Auto tuning	4 1	No	0	1	0 (No)	No
				Yes	1			

3. Function 2Group [FU2]

Code	Description	Keypad Display		Setting Range		Units	Factory Default	Adjustable during run
		LCD	7-segment	LCD	7-segment			
FU2-41	Stator resistance	Rs	41	Decided depending on motor capacity		0.001	Decided depending on motor capacity	No
FU2-42	Leakage inductance	Lsigma	42	Decided depending on motor capacity		0.001	Decided depending on motor capacity	No
FU2-43	Stator inductance	Ls	43	Decided depending on motor capacity		0.001	Decided depending on motor capacity	No
FU2-44	Rotor time constant	Tr	44	Decided depending on motor capacity		1	Decided depending on motor capacity	Yes
FU2-45	P gain for sensorless mode	SL P-gain	45	0 to 3276		1	1000	Yes
FU2-46	I gain for sensorless mode	SL I-gain	46	0 to 3276		1	1000	No
FU2-47	PID operation selection	Proc PI mode	47	0 (No) 1 (Yes)		1	0	No
FU2-48	PID feed forward gain	PID F- gain	48	0-999.9[%]		0.1[%]	0.0[%]	Yes
FU2-49	PID Reference mode selection	PID Ref	49	Freq. Mode	0	1	0 (Freq mode)	No
				Keypad-1	1			
				Keypad-2	2			
				V1	3			
				I	4			
				V1+I	5			
FU2-50	PID Output direction selection	PID Ref Mode	50	Ramp freq	0	1	0 (Ramp freq)	No
				Target freq	1	1		
FU2-51 [10]	PID feedback Signal selection	PID F/B	51	I	0	1	0 (I)	No
				V1	1			
				V2	2			
FU2-52	P Gain for PID Control	PID P-gain	52	0 to 999.9 [%]		1	300.0 [%]	Yes
FU2-53	I Gain for PID Control	PID I-gain	53	0to 32.0 [sec]		1	30.0 [sec]	Yes
FU2-54	D Gain for PID Control	PID D-gain	54	0 to 999.9 [msec]		0.01	0 (No)	Yes
FU2-55	Limit (+) Frequency for PID Control	PID+limit	55	0 to FU1-20		0.01	60.00 [Hz]	Yes
FU2-56	Limit (-) Frequency for PID Control	PID-limit	56	0 to FU1-20		1	60.00 [Hz]	No
FU2-57	PID Output inverter	PID Out Inv.	57	No	0	0.1 [%]	0 (No)	No
				Yes	1			
FU2-58	PID Output gain scale	PID Out Scale	58	0.1 to 999.9 [%]		0.1 [%]	100.0 [%]	No
FU2-59	PID P2 scale	PID P2-gain	59	0.0 to 999.9 [%]		0.1 [%]	100.0 [%]	No
FU2-60	P gain scale	P-gain Scale	60	0.0 to 100 [%]		1	100.0 [%]	Yes
FU2-69	Speed Acc/dec turning point		69					
FU2-70	Reference Frequency for Accel and Decel	Acc/Dec freq	70	Max freq	0	1	0 (Max.frq)	Yes
				Delta freq	1			
FU2-71	Accel/Decel Time scale	Time scale	71	0.01 [sec]	0	1	0 (0.01[sec])	Yes
				0.1 [sec]	1			
				1 [sec]	2			
FU2-72	Power On Display	PowerOn disp	72	0 to 12		1	0	Yes
FU2-73	User Display selection	User disp	73	Voltage	0	1	0 (Voltage)	
				Watt	1			
				Torque	2			
FU2-74	Gain for Motor Speed Display	RPM factor	74	1 to 1000 [%]		1	100 [%]	Yes
FU2-75	DB (Dynamic Braking) Resistor Mode selection	DB mode	75	None	0	1	1 (Int.DB-R)	Yes
				Int. DB-R	1			
				Ext. DB-R	2			
FU2-76 [11]	Duty of Dynamic Braking Resistor	DB %ED	76	0 to 30 [%]			10 [%]	-
FU2-79	Software Version	S/W version	79	ver.1.05		-0.1	Ver.1.05	Yes
FU2-81 [12]	2 nd Acceleration Time	2nd Acc time	81	0 to 6000 [sec]		0.1	5.0 [sec]	Yes
FU2-82	2 nd Deceleration Time	2nd Dec time	82	0 to 6000 [sec]		0.01	10.0 [sec]	No
FU2-83	2 nd Base Frequency	2nd Basefreq	83	30 to FU1-20		1	60.0 [Hz]	No
FU2-84	2 nd Pattern	2nd V/F	84	Liner	0	0.1	0 (Liner)	No
				Square	1			
				User V/F	2			
FU2-85	2 nd Forward Torque Boost	2nd F-boost	85	0 to 15 [%]		0.1	2.0 [%]	No
FU2-86	2 nd Reverse Torque Boost	2nd R-boost	86	0 to 15 [%]		1	2.0 [%]	No
FU2-87	2 nd Stall Prevention Level	2nd Stall	87	30 to 150 [%]		1	150 [%]	Yes
FU2-88	2 nd Electronic Thermal Level for 1 minute	2nd ETH 1min	88	FU2-89 to 200 [%]		1	150 [%]	Yes
FU2-89	2 nd Electronic Thermal Level for continuous	2ndETH cont	89	50 to FU2-88 (maximum150%)		0.1	100 [%]	No
FU2-90	2 nd Rated Motor Current	2nd R-Curr	90	1 to 200 [A]		1	3.6 [A]	No
FU2-91	Read Parameters into Keypad from inverter	Para. Read	91	No	0	1	0 (No)	No
				Yes	1			
FU2-92	Write Parameter to inverter from Keypad	Para. Write	92	No	0	1	0 (No)	No
				Yes	1			
FU2-93	Initialize Parameter	Para. Init	93	No	0	1	0 (No)	Yes
				All group	1			
				DRV	2			
				FU1	3			
				FU2	4			
				I/O	5			
				EXT	6			
FU2-94	Parameter Write Protection	Para. Lock	94	0 to 255		1	0	Yes
FU2-99	Return Code	Not display	99	Not available		-	1	Yes
				[PROG/ENT] or [SHIFT/ESC]				

4. Input / Output [I/O]

Code	Description	Keypad Display		Setting Range		Units	Factory Default	Adjustable during run
		LCD	7-segment	LCD	7-segment			
I/O-00	Jump to desired code#	Jump	Not Displayed	1 to 99	Not available	1	1	Yes
I/O-01	Filtering Time Constant for V1 Signal Input	V1 Filter	I	0 to 9999 [ms]		1	10 [ms]	Yes
I/O-02	V1 Input Minimum Voltage	V1 volt x1	2	0 to 10 [V]		0.01	0.00 [V]	Yes
I/O-03	Frequency corresponding to V1 Input Minimum Voltage	V1 freq y1	3	0 to FU1-20 (Max.freq)		0.01	0.00 [Hz]	Yes
I/O-04	V1 Input Maximum Voltage	V1 volt x2	4	0 to 10 [V]		0.01	10.00 [V]	Yes
I/O-05	Frequency corresponding to V1 Input Minimum Voltage	V1 freq y2	5	0 to FU1-20 (Max.freq)		0.01	60.00 [Hz]	Yes

4. Input / Output [I/O]

Code	Description	Keypad Display		Setting Range		Units	Factory Default	Adjustable during run
		LCD	7-segment	LCD	7-segment			
I/O-06	Filtering Time Constant for V1 Signal Input	I filter	6	0 to 9999 [ms]		1	10 [ms]	Yes
I/O-07	Input Minimum Current	V1 curr x1	7	0 to20 [ms]		0.01	4.00 [mA]	Yes
I/O-08	Frequency corresponding to V1 Input Minimum Voltage	V1 freq y1	8	0 to FU1-20 (Max.freq)		0.01	0.00 [Hz]	Yes
I/O-09	I Input Minimum Current	V1 curr x2	9	0 to20 [ms]		0.01	20.00 [mA]	Yes
I/O-10	Frequency corresponding to I Input Maximum Current	I freq y2	10	0 to FU1-20		0.01	60.00 [Hz]	Yes
I/O-11	Criteria for Analog Input Signal Loss	Wire broken	11	None	0	1	0 (None)	Yes
I/O-12	Multi-function Input Terminal `P1`define	P1 define	12	below x1	1	1	0 (Speed-L)	Yes
				Speed -L	0			
				Speed -M	1			
				Speed -H	2			
				XCEL-L	3			
				XCEL-M	4			
				XCEL-H	5			
				Dc-brake	6			
				2nd Func	7			
				Exchange	8			
				-Reverse-	9			
				Up	10			
				Down	11			
				3-Wire	12			
				Ext Trip-A	13			
				Ext Trip-B	14			
				-Reverse-	15			
				Open-loop	16			
				Main-Drive	17			
				Analog hold	18			
XCEL stop	19							
-Reverse-	20							
SEQ-L	21							
SEQ-M	22							
SEQ-H	23							
Manual	24							
Go step	25							
Hold stepTrv	26							
Off. Lo	27							
Trv Off. Hi	28							
Interlock1	29							
Interlock2	30							
Interlock3	31							
Interlock4	32							
I/O-13	Multi-function Input Terminal `P2`define	P2 define	13	Same as above		1	1 (Speed-M)	Yes
I/O-14	Multi-function Input Terminal `P3`define	P3 define	14	Same as above		1	2 (Speed-H)	Yes
I/O-15	Terminal Input Status	In status	15	000000000 to 11111111		-	000000000	-
I/O-16	Terminal Output Status	Out status	16	0000 to 1111		-	0000	-
I/O-17	Filtering Time Constant for Multi-function Input Terminal	Ti Fit Num	17	2 to 50		1	15	Yes
I/O-20	Jog Frequency setting	Jog freq	20	FU1-22 to FU1-20 (Starting freq to	0.01		10.00 [Hz]	Yes
I/O-21	Step Frequency 4	Step freq-4	21	Max, freq)			40.00 [Hz]	Yes
I/O-22	Step Frequency 5	Step freq-5	22				50.00 [Hz]	Yes
I/O-23	Step Frequency 6	Step freq-6	23				40.00 [Hz]	Yes
I/O-24	Step Frequency 7	Step freq-7	24				30.00 [Hz]	Yes
I/O-25	Acceleration Time 1 for Step Frequency	Acc time-1	25	0 to 6000 [sec]		0.1	20.0 [sec]	Yes
I/O-26	Deceleration Time 1 for Step Frequency	Dec time-1	26	0 to 6000 [sec]		0.1	20.0 [sec]	Yes
I/O-27	Acceleration Time 2	Acc time-2	27	0 to 6000 [sec]		0.1	30.0 [sec]	Yes
I/O-28	Deceleration Time 2	Dec time-2	28	0 to 6000 [sec]		0.1	30.0 [sec]	Yes
I/O-29	Acceleration Time 3	Acc time-3	29	0 to 6000 [sec]		0.1	40.0 [sec]	Yes
I/O-30	Deceleration Time 3	Dec time-3	30	0 to 6000 [sec]		0.1	40.0 [sec]	Yes
I/O-31	Acceleration Time 4	Acc time-4	31	0 to 6000 [sec]		0.1	50.0 [sec]	Yes
I/O-32	Deceleration Time 4	Dec time-4	32	0 to 6000 [sec]		0.1	50.0 [sec]	Yes
I/O-33	Acceleration Time 5	Acc time-5	33	0 to 6000 [sec]		0.1	40.0 [sec]	Yes
I/O-34	Deceleration Time 5	Dec time-5	34	0 to 6000 [sec]		0.1	40.0 [sec]	Yes
I/O-35	Acceleration Time 6	Acc time-6	35	0 to 6000 [sec]		0.1	30.0 [sec]	Yes
I/O-36	Deceleration Time 6	Dec time-6	36	0 to 6000 [sec]		0.1	30.0 [sec]	Yes
I/O-37	Acceleration Time 7	Acc time-7	37	0 to 6000 [sec]		0.1	20.0 [sec]	Yes
I/O-38	Deceleration Time 7	Dec time-7	38	0 to 6000 [sec]		0.1	20.0 [sec]	Yes
I/O-40	FM (Frequency Meter) Output selection	FM mode	40	Frequency	0	1	0 (Frequency)	Yes
				Current	1			
				Voltage	2			
				DC link voltage	3			
I/O-41	FM Output Adjustment	FM adjust	41	10 to 200 [%]		1	100 [%]	Yes
I/O-42	Frequency Detection Level	FDT freq	42	0 to FU1-20		0.01	30.00 [Hz]	Yes
I/O-43	Frequency Detection Bandwidth	FDT band	43	0 to FU1-20		0.01	10.00 [Hz]	Yes
I/O-44	Multi-function Auxiliary Contact Output define(AXA, AXC)	Aux mode	44	FDT-1	0	1	12 (run)	Yes
				FDT-2	1			
				FDT-3	2			
				FDT-4	3			
				FDT-5	4			
				OL	5			
				IOL	6			
				Stall	7			
OV	8							

4. Input / Output [I/O]

Code	Description	Keypad Display		Setting Range		Units	Factory Default	Adjustable during run
		LCD	7-segment	LCD	7-segment			
I/O-44				LV OH Lost Command Run Stop	9 10 11 12 13			
I/O-45	Fault Output Relay setting (30A,30B,30C)	Relay mode	45		000 to 111 (bit set)	-	010 [bit]	Yes
I/O-46 [13]	Inverter Number	Inv No.	46		1 to 32	1	1	Yes
I/O-47	Baud Rate	Baud rate	47		1200bps 2400bps 4800bps 9600bps 19200bps	0 1 2 3 4	3 (9600bps)	Yes
I/O-48	Operation selection at loss of Freq. Reference	lost command	48		None Freerun Stop	0 1 2	0 (None)	Yes
I/O-49	Waiting Time after Loss of Freq. Reference	Time out	49		0.1 to 120[sec]	0.1	0.1 [sec]	Yes
I/O-50	Auto (Sequence)Operation selection	Auto mode	50		None Auto-A Auto-B	0 1 2		No
I/O-51	Sequence Number selection	Seq selet	51		1 to 5	1	0 (None)	Yes
I/O-52	The Number of steps of Sequence Number#	Step number	52		1 to 8	1	1	Yes
I/O-53 [14]	1 st Step Frequency of Sequence	Seq1/1F	53		0.01 to FU1-20 (Max.freq.)	0.01	2	Yes
I/O-54	Transient Time to 1 st Step of Sequence	Seq1/1T	54		0.1 to 6000 [sec]	0.1	11.00 [Hz]	Yes
I/O-55	Steady Speed Time at 1 st Step of Sequence	Seq1/1S	55		0.1 to 6000 [sec]	0.1	1.1 [sec]	Yes
I/O-56	Motor Direction of 1 st Step of Sequence 1	Seq1/1D	56		Reverse Forward	0 1	1.1 [sec]	Yes
I/O-57	1 st Step of Frequency of Sequence 2	Seq1/1F	57		0.01 to FU1-20 (Max.freq.)	0.01	1 (Forward)	Yes
I/O-58	Transient Time to 1 st Step of Sequence 2	Seq1/1T	58		0.1 to 6000 [sec]	0.1	21.00 [Hz]	Yes
I/O-59	Steady Speed Time at 1 st Step of Sequence 2	Seq1/1S	59		0.1 to 6000 [sec]	0.1	1.1 [sec]	Yes
I/O-60	Motor Direction of 1 st Step of Sequence 2	Seq1/1D	60		Reverse Forward	0 1	1.1 [sec]	Yes
I/O-99	Return Code	Not Disp layed	99		Not available [PROG/ENT] or [SHIFT/ESC]	1	1 (Forward) 1	Yes

5. External Group [EXT]

EXT group appears only when the corresponding option boards are installed.

Code	Description	Keypad Display		Setting Range		Units	Factory Default	Adjustable during run	
		LCD	7-segment	LCD	7-segment				
EXT-00	Jump to desired code #	Jump code	Not displayed		0 to 99	1	1	Yes	
EXT-01	Sub board Type display		1		None SUB-A SUB-B SUB-C SUB-D SUB-E	0 1 2 3 4 5	0 (None)	Automatically set	
EXT-02	Multi-function Input Terminal `P4` define	Sub B/C	2		SUB-F SUB-G SUB-H Speed -L Speed -M Speed -H XCEL-L XCEL-M XCEL-H Dc-brake 2nd Func Exchange -Reversed- Up Down 3-Wire Ext Trip-A Ext Trip-B -Reversed- Open-loop Main-Drive Analog hold XCEL stop -Reversed- SEQ-L SEQ-M SEQ-H Manual Go step Hold step Trv Off. Lo Trv Off. Hi	6 7 8 0 1 2 3 4 5 6 7 8 9 10 11 12 13 14 15 16 17 18 19 20 21 22 23 24 25 26 27 28	1	3 (XCEL-L)	Yes

5. External Group [EXT]

EXT group appears only when the corresponding option boards are installed.

Code	Description	Keypad Display		Setting Range		Units	Factory Default	Adjustable during run
		LCD	7-segment	LCD	7-segment			
EXT-02				Interlock1	29			
				Interlock2	30			
				Interlock3	31			
				Interlock4	32			
EXT-03	Multi-function Input Terminal `P5` define	P5 define	3	Same as above			4 (XCEL-M)	Yes
EXT-04	Multi-function Input Terminal `P6` define	P6 define	4	Same as above			5 (XCEL-H)	Yes
EXT-05	V2 Mode selection	V2 mode	5	None	0		0 (None)	No
				Override	1			
				Reference	2			
EXT-06	Filtering Time Constant for V2 Signal Input	V2 filter	6	0 to 10000 [ms]		1	10 [ms]	Yes
EXT-07	V2 Input Minimum Voltage	V2 volt x1	7	0 to 10 [V]		0.01	0.00 [V]	Yes
EXT-08	Frequency corresponding to V2 Input Minimum Voltage	V2 freq y2	8	0 to FU1-20 (Max.freq.)		0.01	0.00 [Hz]	Yes
EXT-09	V2 Input Maximum Voltage	V2 volt x2	9	0 to 10 [V]		0.01	10.00 [V]	Yes
EXT-10	Frequency corresponding to V2 Input Maximum Voltage	V2 freq y2	10	0 to FU1-20 (Max.freq.)		0.01	60.00 [Hz]	Yes
EXT-14	Usage of Pulse Input Signal	F mode	14	None	0		0 (None)	No
				Fee-back	1			
				Reference	2			
EXT-15	Pulse Input Signal selection	F pulse set	15	A+B	0		0 (A+B)	Yes
				A	1			
EXT-16	Encoder Pulse Number	F pulse num	16	360 to 4096		1	1024	No
EXT-17	Filtering Time Constant for Pulse Input Signal	F filter	17	0 to 9999 [ms]		1	10 [ms]	Yes
EXT-18	Pulse Input Minimum Frequency	F pulse x1	18	0 to 100 [kHz]		0.01	0.00 [kHz]	Yes
EXT-19	Frequency Output corresponding to Pulse Input Minimum Frequency	F freq y1	19	0 to FU1-20 (Max.freq.)		0.01	0.00 [Hz]	Yes
EXT-20	Pulse Input Maximum Frequency	F pulse x2	20	0 to 100 [kHz]		0.01	10.00 [kHz]	Yes
EXT-21	Frequency Output corresponding to Pulse Input Maximum Frequency	F freq y2	21	0 to FU1-20 (Max.freq.)		0.01	60.00 [Hz]	Yes
EXT-22	P-Gain for `Sub-B`	PG P-gain	22	0 to 9999		1	3000	Yes
EXT-23	I-Gain for `Sub-B`	PG I-gain	23	0 to 9999		1	300	Yes
EXT-24	Slip P-Gain for Frequency `Sub-B` board	PG Slip freq	24	0 to 20[%]		1	100 [%]	Yes
EXT-30	Multi-function Output Terminal `Q1` define	Q1 define	30	FDT-1	0		0 (FDT-1)	Yes
				FDT-2	1			
				FDT-3	2			
				FDT-4	3			
				FDT-5	4			
				OL	5			
				IOL	6			
				Stall	7			
				OV	8			
				LV	9			
				OH	10			
				Lost Command	11			
				Run	12			
				Stop	13			
				Steady	14			
				INV line	15			
				COMM line	16			
				Search	17			
				Step pulse	18			
				Seq pulse	19			
				Ready	20			
				Trv. ACC	21			
				Trv. DEC	22			
				MMC	23			
EXT-31	Multi-function Output Terminal `Q2` define	Q2 define	31	Same as above			1 (FDT-2)	Yes
EXT-32	Multi-function Output Terminal `Q3` define	Q3 define	32	Same as above			2 (FDT-3)	Yes
EXT-34	LM (Load Meter)Output selection	LM mode	34	Frequency	0		1 (Current)	Yes
				Current	1			
				Voltage	2			
				DC link Vtg	3			
EXT-35	LM (Load Meter) Adjustment	LM adjust	35	100 to 200 [%]			100 [%]	Yes
EXT-40	AM1 (Analog Meter1)Output selection	AM1 mode	40	Frequency	0		0 (Frequency)	Yes
				Current	1			
				Voltage	2			
				DC link Vtg	3			
EXT-41	AM1 (Analog Meter1)Output Adjustment	AM1 adjust	41	100 to 200 [%]			100 [%]	Yes
EXT-42	AM2 (Analog Meter2)Output selection	AM2 mode	42	Frequency	0		3 (DC link Vtg)	Yes
				Current	1			
				Voltage	2			
				DC link Vtg	3			
EXT-43	AM2 (Analog Meter2)Output Adjustment	AM2 adjust	43	100 to 200[%]			100 [%]	Yes
EXT-99	Return Code	Not displayed	99	Not available	[PROG/ENT] or [SHIFT/ESC]		1	Yes

6. Communication Group [COM]

Code	Description	Keypad Display		Setting Range		Units	Factory Default	Adjustable during run
		LCD	7-segment	LCD	7-segment			
COM-00	Jump to desired code #	Jump code	Not Displayed	0 to 99	Not available	1	1	Yes
COM-01	Option board Type display	Opt B/D	1	None Device Net Synchro PLC-GF Profibus-DP Digital-in RS485 Modbus-RTU	0 1 2 3 4 5 6 7	1	0 (None)	Yes
COM-02	Option mode	Opt Mode	2	None Command Frequency Cmd+Freq	0 1 2 3	1	0 (None)	No
COM-03	Option version	Opt Version	3	Option version				No
COM-04	Digital (Binary)option input mode selection	D-in Mode	4	8bit Bin 8 BCD 1% 8 BCD 1Hz 12 Bit Bin 12 BCD 0.1% 12 BCD 0.1Hz 12 BCD 1Hz	1 2 3 4 5 6 7	1	0 (8BitBin)	Yes
COM-05	Digital (Binary)input filter	Digital Ftr	5	0 to 50		1	15	Yes
COM-10	Device Net ID	MAC ID	10	0 to 63		1	0	Yes
COM-11	Device Net baud rate	Baud Rate	11	125kbps 250kbps 500kbps	0 1 2	1	0 (125 bps)	Yes
COM-12	Device Net output impedance	Out Instance	12	20 21 100 101	0 1 2 3	1	0 (20)	Yes
COM-13	Device Net input impedance	In Instance	13	70 71 110 111	0 1 2 3	1	0 (70)	Yes
COM-17	PLC station ID	Station ID	17	0 to 63		1	1	Yes
COM-20	Profibus-DP ID	Profi MAC ID	20	0 to 127		1	1	Yes
COM-30	Number of output	Output Num	30	0 to 8		1	3	Yes
COM-31	Output 1	Output 1	31	0000 to 57FF (HEX)		-	000A (HEX)	Yes
COM-32	Output 2	Output 1	32	0000 to 57FF (HEX)		-	000A (HEX)	Yes
COM-33	Output 3	Output 1	33	0000 to 57FF (HEX)		-	000A (HEX)	Yes
COM-34	Output 4	Output 1	34	0000 to 57FF (HEX)		-	000A (HEX)	Yes
COM-35	Output 5	Output 1	35	0000 to 57FF (HEX)		-	000A (HEX)	Yes
COM-36	Output 6	Output 1	36	0000 to 57FF (HEX)		-	000A (HEX)	Yes
COM-37	Output 7	Output 1	37	0000 to 57FF (HEX)		-	000A (HEX)	Yes
COM-38	Output 8	Output 1	38	0000 to 57FF (HEX)		-	000A (HEX)	Yes
COM-40	Number of input	Input Num	40	0 to 8		1	2	Yes
COM-41	Input 1	Input 1	41	0000 to 57FF (HEX)		-	000A (HEX)	Yes
COM-42	Input 2	Input 2	42	0000 to 57FF (HEX)		-	000A (HEX)	Yes
COM-43	Input 3	Input 3	43	0000 to 57FF (HEX)		-	000A (HEX)	Yes
COM-44	Input 4	Input 4	44	0000 to 57FF (HEX)		-	000A (HEX)	Yes
COM-45	Input 5	Input 5	45	0000 to 57FF (HEX)		-	000A (HEX)	Yes
COM-46	Input 6	Input 6	46	0000 to 57FF (HEX)		-	000A (HEX)	Yes
COM-47	Input 7	Input 7	47	0000 to 57FF (HEX)		-	000A (HEX)	Yes
COM-48	Input 8	Input 8	48	0000 to 57FF (HEX)		-	000A (HEX)	Yes
COM-52	Modbus-RTU mode	ModBus Mode	52	Modbus-RTU		-	ModBus-RTU	Yes
COM-99	Return Code	not displayed	99	Not available	[PROG/ENT] or [SHIFT/ESC]	-	1	Yes

7. Application Group [APP]

Code	Description	Keypad Display		Setting Range		Units	Factory Default	Adjustable during run
		LCD	7-segment	LCD	7-segment			
APP-00	Jump to desired code #	Jump code	Not Displayed	0 to 99	Not available	1	1	Yes
APP-01	Application mode	App Mode	1	None Traverse MMC DRAW	0 1 2 3	1	0 (None)	No
APP-02	Traverse operation band	Trv. Amp	2	0.0 to 20.0 [%]		0.1	0.0 [%]	Yes
APP-03	Traverse scramble band	Trv. Scr	3	0.0 to 50.0 [%]		0.1	0.0 [%]	Yes
APP-04	Traverse acceleration time	Trv Acc Time	4	0.1 to 6000 [sec]		0.1	2.0 [sec]	Yes
APP-05	Traverse deceleration time	Trv Dec Time	5	0.1 to 6000 [sec]		0.1	3.0 [sec]	Yes
APP-06	Traverse offset High	Trv Off Hi	6	0.0 to 20.0 [%]		0.1	0.0 [%]	Yes
APP-07	Traverse offset Low	Trv Off Lo	7	0.0 to 20.0 [%]		0.1	0.0 [%]	Yes
APP-08	No. of Aux. Motor in running	Aux Mot Run	8	#		-	#	-
APP-09	Start aux. Motor	Start Aux	9	1 to 4		1	1	Yes
APP-10	Operation time display by auto-change	Auto Op Time	10	#		0.01	#	-
APP-11	Starting frequency of Aux. Motor 1	Start freq 1	11	0 to FU1-20 (Max.freq)		0.01	49.99 [Hz]	Yes
APP-12	Starting frequency of Aux. Motor 2	Start freq 2	12	0 to FU1-20 (Max.freq)		0.01	49.99 [Hz]	Yes
APP-13	Starting frequency of Aux. Motor 3	Start freq 3	13	0 to FU1-20 (Max.freq)		0.01	49.99 [Hz]	Yes
APP-14	Starting frequency of Aux. Motor 4	Start freq 4	14	0 to FU1-20 (Max.freq)		0.01	49.99 [Hz]	Yes

7. Application Group [APP]

Code	Description	Keypad Display		Setting Range		Units	Factory Default	Adjustable during run
		LCD	7-segment	LCD	7-segment			
APP-17	Starting frequency of Aux. Motor 3	Stop freq 3	17	0 to FU1-20 (Max.freq)		0.01	15.00 [Hz]	Yes
APP-18	Starting frequency of Aux. Motor 4	Stop freq 4	18	0 to FU1-20 (Max.freq)		0.01	15.00 [Hz]	Yes
APP-19	Aux.Motor starting delay time	Aux start DT	19	0.0 to 9999 [sec]		0.1	60.00 [sec]	Yes
APP-20	Aux.Motor stop delay time	Aux stop DT	20	0.0 to 9999 [sec]		0.1	60.00 [sec]	Yes
APP-21	Number of Aux. Motor	Nbr Aux' s	21	0 to 4		1	4	Yes
APP-22	Bypass selection	Regul Bypass	22	None Yes	0 1	1	0 (None)	Yes
APP-23	Sleep delay	Sleep Delay	23	0.0 to 9999 [sec]		0.1	60.00 [sec]	Yes
APP-24	Sleep frequency	Sleep Freq	24	0 to FU1-20 (Max.freq)		0.01	19.00 [Hz]	Yes
APP-25	Wakeup level	Wakeup level	25	0.0 to 100.0 [%]		0.1	35.0 [%]	Yes
APP-26	Auto change mode selection	AutoCh_Mode	26	0 to 2		1	1	Yes
APP-27	Auto change time	AutoCh_intv	27	00:00 to 99:00		00 : 01	72:00	Yes
APP-28	Auto change level	AutoCh_Mode level	28	0.0 to 100.0 [%]		0.1	20.0 [%]	Yes
APP-29	Interlock selection	Inter-lock	29	None Yes	0	1	0 (None)	Yes
APP-30	Actual value display	Actal Value	30	#	1	-	#	-
APP-31	Actual value percentage	Actal Perc	31	#	0	-	#	-
APP-32	Draw mode selection	Draw Mod	32	V1_Draw L_Draw V2_Draw	1 2 3	1	0(None)	Yes
APP-33	Draw percentage selection	DrawPerc	22	0.0 to 150.0 [%]		0.1	00.0 [%]	Yes

Note)Sub-Board Selection Guide according to its Function

Code	Function Description	Keypad Display		Sub-Board Type		
		LCD	7-segment	Sub-A Board	Sub-A Board	Sub-C Board
EXT-01	Sub-board selection	Sub B/D	1			
EXT-02	Multi-function Input Terminal `P4`	P4 define	2			
EXT-03	Multi-function Input Terminal `P5`	P5 define	3			
EXT-04	Multi-function Input Terminal `P6`	P6 define	4			
EXT-05	V2 Mode selection	V2 mode	5			
EXT-06	Filtering Time Constant for V2 Input Signal	V2 filter	6			
EXT-07	V2 Input Minnnum Voltage	V2 volt x1	7			
EXT-08	Frequency corresponding to V2 Input Minnnum Voltage	V2 freq y1	8			
EXT-09	V2 Input Maximum Voltage	V2 volt x2	9			
EXT-10	Frequency corresponding to V2 Input Maximum Voltage	V2 freq y2	10			
EXT-14	Usage for Pulse Input Signal	F mode	14			
EXT-15	Pulse Input Signal selection	F pulse set	15			
EXT-16	Encoder Pulse selection	F pulse num	16			
EXT-17	Filtering Time Constant for pulse Input Signal	F filter	17			
EXT-18	Pulse Input Minimum Frequency	F pulse x1	18			
EXT-19	Frequency Output corresponding to Pulse Input Minimum Frequency	f freq y1	19			
EXT-20	Pulse Input Maximum Frequency	F pulse x2	20			
EXT-21	Frequency Output corresponding to Pulse Input Minimum Frequency	f freq y2	21			
EXT-22	P-Gain for PG Option	PG P-gain	22			
EXT-23	I-Gain for PG Option	PG I-gain	23			
EXT-24	Slip Frequency for PG Option	PG Slip freq	24			
EXT-30	Multi-function Output Terminal `Q1`	q1 define	30			
EXT-31	Multi-function Output Terminal `Q2`	q2 define	31			
EXT-32	Multi-function Output Terminal `Q3`	q3 define	32			
EXT-34	LM (Load Meter) Output selection	LM mode	34			
EXT-35	LM (Load Meter) Output Adjustment	LM adjust	35			
EXT-40	AM1 (Analog Meter1) Output selection	AM1 mode	40			
EXT-41	AM1 (Analog Meter1) Output Adjustment	AM1 adjust	41			
EXT-42	AM2 (Analog Meter2) Output selection	Am2 mode	42			
EXT-43	AM2(Analog Meter2) Output Adjustment	AM2 adjust	43			

[1] Code FU1-08 through FU1-11 appears only when FU1-07 is set at 'DC-brake'.

[2] Code FU1-24 through FU1-25 appears only when FU1-23 is set at 'Yes'.

[3] Code FU1-30 through FU1-37 appears only when FU1-29 is set at 'User V/F'.

[4] Code FU1-51 through FU1-53 appears only when FU1-50 is set at 'Yes'.

[5] Code FU2-11 through FU2-16 appears only when FU2-10 is set at 'Yes'.

[6] The rated motor is automatically set according to the inverter model name. If different motor is used, set the rated motor capacity connected.

[7] This value is automatically entered according to the rated motor set in FU2-30. If different, set the correct value as the motor.

[8] The setting range of carrier frequency is decided depending on drives' capacity (over 30kW).

[9] This value is automatically entered according to the rated motor set in FU2-30. If different, set the correct value as the motor.

[10] Code FU2-47 through FU2-60 appears only when FU2-39 is set at 'PID'.

[11] Code FU2-76 appears only when FU2-75 is set at 'Ext.DB-R'.

[12] Code FU2-81 through FU2-90 appears only when one of I/O-12 ~ I/O-14 is set at '2nd function'.

[13] Code/O-46 through I/O-53 are used in Option Board like RS485, Device Net and F-net etc.

[14] The 'Seq#' of code I/O-53 through I/O-60 varies according to the sequence number selected in I/O-51.

The parameter code may be extended to I/O-84 depend on the number of steps set in I/O-52 because the steps can be set up to 8.

Dimension (mm)

- 1. SV008iS5-2
- SV015iS5-2
- SV022iS5-2
- SV037iS5-2
- SV055iS5-2
- SV075iS5-2
- SV008iS5-4
- SV015iS5-4
- SV022iS5-4
- SV037iS5-4
- SV055iS5-4
- SV075iS5-4

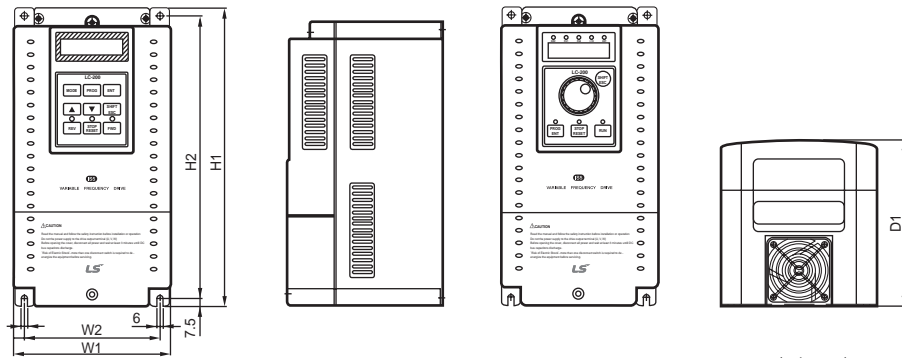

(unit : mm)

Inverter	W1	W2	H1	H2	D2
SV008iS5-2/4	150	130	284	269	156.5
SV015iS5-2/4	150	130	284	269	156.5
SV022iS5-2/4	150	130	284	269	156.5
SV037iS5-2/4	150	130	284	269	156.5
SV055iS5-2/4	200	180	355	340	182.5
SV075iS5-2/4	200	180	355	340	182.5

- 2. SV110iS5-2
- SV150iS5-2
- SV185iS5-2
- SV220iS5-2
- SV110iS5-4
- SV150iS5-4
- SV185iS5-4
- SV220iS5-4

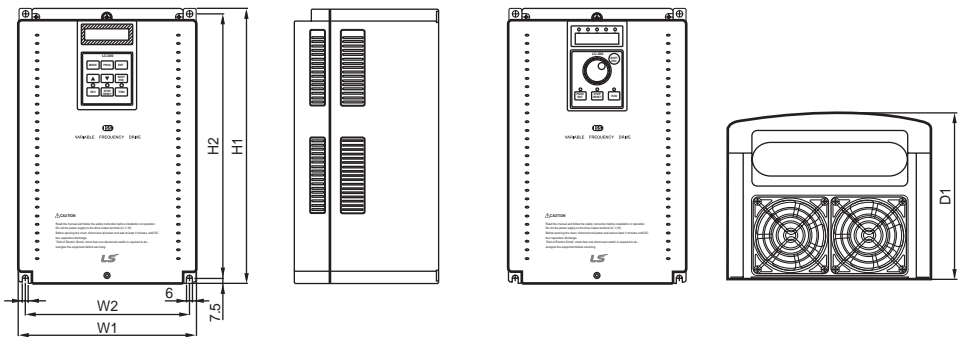

(unit : mm)

Inverter	W1	W2	H1	H2	D2
SV110iS5-2/4	250	230	385	370	201
SV150iS5-2/4	250	230	385	370	201
SV185iS5-2/4	304	284	460	445	234
SV220iS5-2/4	304	284	460	445	234

- 3. SV300iS5-2
- SV370iS5-2
- SV450iS5-2
- SV550iS5-2
- SV300iS5-4
- SV370iS5-4
- SV450iS5-4
- SV550iS5-4
- SV750iS5-4

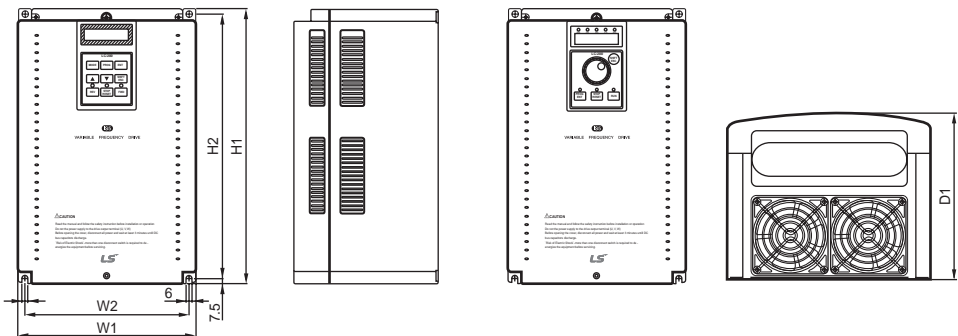

(unit : mm)

Class	Type	W1	W2	W3	H1	H2	D1	D2
200-230V	SV300iS5-2	375	360	275	615	593.5	277.5	230.5
	SV370iS5-2	375	360	275	615	593.5	277.5	230.5
	SV450iS5-2	375	360	275	780	758.5	300.7	230.5
	SV550iS5-2	375	360	275	780	758.5	300.7	230.5
380-480V	SV300iS5-4	350	319.2	270	680	662	311.2	256.6
	SV370iS5-4	350	319.2	270	680	662	311.2	256.6
	SV450iS5-4	375	359.6	275	780	760.5	329	259
	SV550iS5-4	375	359.6	275	780	760.5	329	259
	SV750iS5-4	375	359.6	275	780	760.5	329	259

Options

Option	Name	Description		
Internal Installation	Sub Board	Sub-A Board (Extended I/O)	Extended I/O module 3 multi-function inputs (P4, P5, P6) 3 multi-function outputs (Q1, Q2, Q3) Auxiliary analog frequency reference (V2) Lm (Load meter) Output (0 – 10V)	
		Sub-B Board (speed Feedback)	Encoder pulse input-Speed feedback (AOC, BOC /A+, A-, B+ B-) Encoder pulse output (FBA, FBB)	
		Sub-C Board (Extended I/O)	Extended I/O module 3 multi-function inputs (P4, P5, P6) 1 multi-function outputs (Q1) Isolated auxiliary analog frequency reference (V2) 2 Isolated analog meter output (AM1.AM2)	
	Option Board	Device Net	Embedded DeviceNet protocol Can Control Inverter Connection : Max.64 Input Voltage : DC 11 ~25V Baud Rate : 125, 250, 500k bps CSMA/CD-NBA method	
		PLC Communication (F-Net)	Connection with Fnet communication module of GLOFA PLC Inverter Connection : Max.64 Baud Rate : Max. 1M bps Token method	
		RS-485	RS-485 Communication Inverter Connection : Max.32 Baud Rate : Max. 19200 bps	
		Profi-Bus	Connection to Profibus network Device Type : Profibus Dp Slave Inverter Connection : Max. 64 Baud Rate : Max. 12M bps	
		ModBus-RTU	ModBus-RTU Communication Inverter Connection : Max. 32 Baud Rate : Max.19200bps	
	External Installation	Keypad	LCD	32 Character display Download and Upload from the keypad
			LED (7-segment)	6 digit 7-segment display
Remote Cable		Remote Cable	2m, 3m, 5m long keypad cables for separate keypad installation.	
Dynamic Braking		DB Resistor	Enables inverter to decelerate rapidly	
		DB Unit	DB units are provided as an option for 15~75kW inverters	

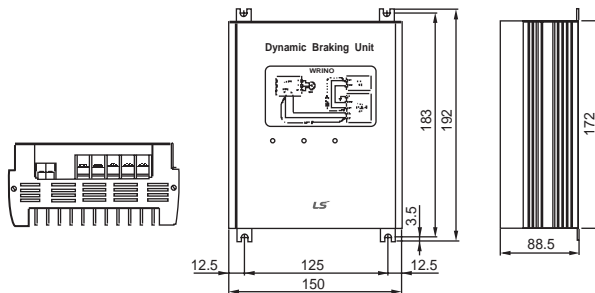

Dynamic braking (DB)unit

Model Name	SV150DBU-2	SV220DBU-2	SV370DBU-2	SV550DBU-4	SV150DBU-4	SV220DBU-4	SV370DBU-4	SV550DBU-4	SV750DBU-4	
Max. DC Input Voltage	DC400V	DC400V	DC400V	DC400V	DC800V	DC800V	DC800V	DC800V	DC800V	
Application Motor [kW]	15 20 25 30	30 37 45 55	15 20 25 30 37 45 55	22.4 30 37 45 55 75	2.4 3.6 6.4 9.6	22.4 30 37 45 55 75	3.6 6.4 9.6 12.8	15 20 25 30 37 45 55 75	2.4 3.6 6.4 9.6 12.8	
DB Resistor	Wattage [kW]*		Resistor Value [Ω]		Wattage [kW]*		Resistor Value [Ω]		Wattage [kW]*	
	15	10	5	4.2	2.8	4030	20	16.9	11.4	8.4
Average Braking Torque	150%	150%	100%	100%	150%	150%	150%	100%	100%	
Enable Duty (ED)	50%	50%		10%	10%	10%	10%	10%	10%	
Output Signal	Heat sink over-heat signal output									
Protection	Heat sink over-heat output cut-off									
Environment Ambient Temp.	-10°C ~ 40°C									
Humidity	Below 90% Relative Humidity (Non Condensing)									
Altitude	Less than 3,300ft (1,000m) without derating									
Cooling Method	Self-cooling									
Installation	Avoid corrosive gas, oil mist, flammable gas and dust									

*This resistor wattage is based on 150% braking torque and 5% ED. Double the wattage in case of using with 10% ED application.

Dynamic braking (DB) unit

1. Internal (built-in) resistors

The DB resistors are built-in for 0.75 ~ 3.7kW models.

Model Name	kW	Internal DB Resistor	ED / Continuous Braking time
SV008iS5-2	0.75	200 Ω, 100Watt	3% / 5seconds
SV015iS5-2	1.5	100 Ω, 100Watt	3% / 5seconds
SV022iS5-2	2.2	60 Ω, 100Watt	2% / 5seconds
SV037iS5-2	3.7	40 Ω, 100Watt	2% / 5seconds
SV008iS5-2	0.75	900 Ω, 100Watt	3% / 5seconds
SV015iS5-2	1.5	450 Ω, 100Watt	3% / 5seconds
SV022iS5-2	2.2	300 Ω, 100Watt	2% / 5seconds
SV037iS5-2	3.7	200 Ω, 100Watt	2% / 5seconds

*Above table is based on 100% braking torque

2. External (optional) resistors

Model Name	kW	DB Resistor (100% Braking Torque)	DB Resistor (150% Braking Torque)
SV008iS5-2	0.75	200 Ω, 100Watt	150 Ω, 150Watt
SV015iS5-2	1.5	100 Ω, 200Watt	60 Ω, 300Watt
SV022iS5-2	2.2	60 Ω, 300Watt	50 Ω, 400Watt
SV037iS5-2	3.7	40 Ω, 500Watt	33 Ω, 600Watt
SV055iS5-2	5.5	3 Ω, 700Watt	20 Ω, 800Watt
SV075iS5-2	7.5	20 Ω, 1000Watt	15 Ω, 1200Watt
SV110iS5-2	11	15 Ω, 1400Watt	10 Ω, 2400Watt
SV150iS5-2	15	11 Ω, 2000Watt	8 Ω, 2400Watt
SV185iS5-2	18.5	9 Ω, 2400Watt	5Ω, 3600Watt
SV220iS5-2	22	8 Ω, 2800Watt	5Ω, 3600Watt
SV300iS5-2	30	4.2 Ω, 6400Watt	-
SV370iS5-2	37	4.2 Ω, 6400Watt	-
SV450iS5-2	45	2.8 Ω, 9600Watt	-
SV550iS5-2	55	2.8 Ω, 9600Watt	-
SV008iS5-4	0.75	900 Ω, 100Watt	600 Ω, 150Watt
SV015iS5-4	1.5	450 Ω, 200Watt	300 Ω, 300Watt
SV022iS5-4	2.2	300 Ω, 300Watt	200 Ω, 400Watt
SV037iS5-4	3.7	200 Ω, 500Watt	130 Ω, 600Watt
SV055iS5-4	5.5	120 Ω, 700Watt	85 Ω, 1000Watt
SV075iS5-4	7.5	90 Ω, 1000Watt	60 Ω, 1200Watt
SV110iS5-4	11	60 Ω, 1400Watt	40 Ω, 2000Watt
SV150iS5-4	15	45 Ω, 2000Watt	30 Ω, 2400Watt
SV185iS5-4	18.5	35 Ω, 2400Watt	20 Ω, 3600Watt
SV220iS5-4	22	30 Ω, 2800Watt	20 Ω, 3600Watt
SV300iS5-4	30	16.9 Ω, 6400Watt	-
SV370iS5-4	37	16.9 Ω, 6400Watt	-
SV450iS5-4	45	11.4 Ω, 9600Watt	-
SV550iS5-4	55	11.4 Ω, 9600Watt	-
SV750iS5-4	75	8.4 Ω, 12800Watt	-

*Above table is based on 100% braking torque

Peripheral Devices

Inverter Models	HP	MCCB, ELB	Magnetic Contactor	Wire, mm2 (AWG)			AC Input Fuse	AC Reactor	DC Reactor
				R,S,T	U,V,W	Ground			
SV008iS5-2	1	ABS33a, EBS33	SMC-10P	2 (14)	2 (14)	3.5 (12)	10A	2.13mH, 5.7A	7.00mH, 5.7A
SV015iS5-2	2	ABS33a, EBS33	SMC-10P	2 (14)	2 (14)	3.5 (12)	15A	1.20mH, 10A	4.05mH, 9.2A
SV022iS5-2	3	ABS33a, EBS33	SMC-15P	2 (14)	2 (14)	3.5 (12)	25A	0.88mH, 14A	2.92mH, 13A
SV037iS5-2	5	ABS33a, EBS33	SMC-20P	3.5 (12)	3.5 (12)	3.5 (12)	40A	0.56mH, 20A	1.98mH, 19A
SV055iS5-2	7.5	ABS53a, EBS53	SMC-25P	5.5 (10)	5.5 (10)	5.5 (10)	40A	0.39mH, 30A	1.37mH, 29A
SV075iS5-2	10	ABS63a, EBS63	SMC-35P	8 (8)	8 (8)	5.5 (10)	50A	0.28mH, 40A	1.05mH, 38A
SV110iS5-2	15	ABS103a, EBS103	SMC-50P	14 (6)	14 (6)	14 (6)	70A	0.20mH, 59A	0.74mH, 56A
SV150iS5-2	20	ABS103a, EBS103	SMC-65P	22 (4)	22 (4)	14 (6)	100A	0.15mH, 75A	0.57mH, 71A
SV185iS5-2	25	ABS203a, EBS203	SMC-80P	30 (3)	30 (3)	22 (4)	100A	0.12mH, 96A	0.49mH, 91A
SV220iS5-2	30	ABS203a, EBS203	SMC-100P	38 (2)	30 (3)	22 (4)	125A	0.10mH, 112A	0.42mH, 107A
SV300iS5-2	40	ABS203a, EBS225	GMC-150	60	60	22	150A	0.08mH, 134.2A	0.35mH, 152.0A
SV370iS5-2	50	ABS203a, EBS225	GMC-180	60	60	22	200A	0.07mH, 160.6A	0.3mH, 180.0A
SV450iS5-2	60	ABS403a, EBS300	GMC-220	100	100	38	250A	0.06mH, 198.0A	0.28mH, 221.0A
SV550iS5-2	75	ABS403a, EBS350	GMC-300	100	100	38	300A	0.05mH, 242.0A	0.25mH, 270.0A
SV008iS5-4	1	ABS33a, EBS33	SMC-10P	2 (14)	2 (14)	2 (14)	6A	8.63mH, 2.8A	28.62mH, 2.7A
SV015iS5-4	2	ABS33a, EBS33	SMC-10P	2 (14)	2 (14)	2 (14)	10A	4.81mH, 4.8A	16.14mH, 4.6A
SV022iS5-4	3	ABS33a, EBS33	SMC-20P	2 (14)	2 (14)	2 (14)	10A	3.23mH, 7.5A	11.66mH, 7.1A
SV037iS5-4	5	ABS33a, EBS33	SMC-20P	3.5 (12)	2 (14)	2 (14)	20A	2.34mH, 10A	7.83mH, 10A
SV055iS5-4	7.5	ABS33a, EBS33	SMC-20P	3.5 (12)	2 (14)	3.5 (12)	20A	1.22mH, 15A	5.34mH, 14A
SV075iS5-4	10	ABS33a, EBS33	SMC-20P	5.5 (10)	3.5 (12)	3.5 (12)	30A	1.14mH, 20A	4.04mH, 19A

Peripheral Devices

Inverter Models	kW	MCCB, ELB	Magnetic Contactor	Wire, mm2 (AWG)			AC Input Fuse	AC Reactor	DC Reactor
				R,S,T	U,V,W	Ground			
SV110iS5-4	15	ABS53a, EBS53	SMC-20P	8 (8)	5.5 (10)	8 (8)	35A	0.81mH, 30A	2.76mH, 29A
SV150iS5-4	20	ABS63a, EBS63	SMC-25P	14 (6)	8 (8)	8 (8)	45A	0.61mH, 38A	2.18mH, 36A
SV185iS5-4	25	ABS103a, EBS103	SMC-35P	14 (6)	8 (8)	14 (6)	60A	0.45mH, 50A	1.79mH, 48A
SV220iS5-4	30	ABS103a, EBS103	SMC-50P	22 (4)	14 (6)	14 (6)	70A	0.39mH, 58A	1.54mH, 55A
SV300iS5-4	40	ABS203a, EBS125	GMC-85	22	22	14	100A	0.33mH, 67.1A	1.19mH, 76.0A
SV370iS5-4	50	ABS203a, EBS150	GMC-100	22	22	14	100A	0.27mH, 82.5A	0.98mH, 93.0A
SV450iS5-4	60	ABS203a, EBS175	GMC-125	38	38	22	100A	0.22mH, 100.1A	0.89mH, 112.0A
SV550iS5-4	75	ABS203a, EBS225	GMC-150	38	38	22	150A	0.18mH, 121.0A	0.75mH, 135.0A
SV750iS5-4	100	ABS203a, EBS225	GMC-180	60	60	22	200A	0.13mH, 167.2A	0.44mH, 187.0A

RFI Filter

IS5 Series			Footprinting Filter							
Inverter	Power	Code	Current	Tension Voltage	Leakage Current	Dimensions L W H	Mounting Y X	Weight	Mount	Output Chokes
THREE PHASE			NOM.	MAX.						
SV008iS5-2	0.75kW	FFS5-T012-(X)	12A	250VA	0.3A 18A	329 X 149.5 X 50	315 X 120		M5	FS-2
SV015iS5-2	1.5kW									
SV022iS5-2	2.2kW	FFS5-T020-(X)	20A	250VA	0.3A 18A	329 X 149.5 X 50	315 X 120		M5	FS-2
SV037iS5-2	3.7kW									
SV055iS5-2	5.5kW	FFS5-T030-(X)	30A	250VA	0.3A 18A	415 X 199.5 X 60	410 X 160		M5	FS-2
SV075iS5-2	7.5kW			50A	250VA	0.3A 18A	415 X 199.5 X 60	410 X 160		M5
SV110iS5-2	11kW	FFS5-T050-(X)	100A	250VA	0.3A 18A					FS-3
SV150iS5-2	15kW									
SV185iS5-2	18kW	FFS5-T006-(X)	120A	250VA	0.3A 18A					FS-3
SV220iS5-2	22kW									
SV008iS5-4	0.75kW	FFS5-T006-(X)	6A	380VA	0.5A 27A	329 X 149.5 X 50	315 X 120		M5	FS-1
SV015iS5-4	1.5kW									
SV022iS5-4	2.2kW	FFS5-T012-(X)	12A	380VA	0.5A 27A	329 X 149.5 X 50	315 X 120		M5	FS-2
SV037iS5-4	3.7kW									
SV055iS5-4	5.5kW	FFS5-T030-(X)	30A	380VA	0.5A 27A	415 X 199.5 X 60	401 X 160		M5	FS-2
SV075iS5-4	7.5kW									
SV110iS5-4	11kW	FFS5-T051-(X)	51A	380VA	0.5A 27A	466 X 258 X 65	515.5 X 255		M8	FS-2
SV150iS5-4	15kW									
SV185iS5-4	18kW	FFS5-T060-(X)	60A	380VA	0.5A 27A	541 X 332 X 65	515.5 X 255		M8	FS-2
SV220iS5-4	22kW			70A	380VA	0.5A 27A	541 X 332 X 65		M8	FS-2

IS5 Series			Standard Filter							
Inverter	Power	Code	Current	Tension Voltage	Leakage Current	Dimensions L W H	Mounting Y X	Weight	Mount	Output Chokes
THREE PHASE			NOM.	MAX.						
SV008iS5-2	0.75kW	FE-T012-(X)	12A	250VA	0.3A 18A	250 X 110 X 60	238 X 76		--	FS-2
SV015iS5-2	1.5kW									
SV022iS5-2	2.2kW	FE-T020-(X)	20A	250VA	0.3A 18A	270 X 140 X 60	258 X 106		--	FS-2
SV037iS5-2	3.7kW									
SV055iS5-2	5.5kW	FE-T030-(X)	30A	250VA	0.3A 18A	270 X 140 X 60	258 X 106		--	FS-2
SV075iS5-2	7.5kW			50A	250VA	0.3A 18A	270 X 140 X 60	258 X 106		--
SV110iS5-2	11kW	FE-T100-(x)	100A	250VA	0.3A 18A	420 X 200 X 130	408 X 166		--	FS-3
SV150iS5-2	15kW									
SV185iS5-2	18kW	FE-T120-(x)	120A	250VAC	1.3A 180A	420 X 200 X 130	408 X 106		--	FS-3
SV220iS5-2	22kW									
SV300iS5-2	30kW	FE-T150-2	150A	250VAC	1.3A 150A	480 X 200 X 160	468 X 166		--	FS-3
SV370iS5-2	37kW			170A	250VAC	1.3A 150A	480 X 200 X 160	468 X 166		--
SV450iS5-2	45kW	FE-T230-2	230A	250VAC	1.3A 150A	580 X 250 X 205	560 X 170		--	FS-4
SV550iS5-2	55kW			280A	250VAC	1.3A 150A	580 X 250 X 205	560 X 170		--
SV008iS5-4	0.75kW	FE-T006-(X)	6A	380VAC	0.5A 27A	250 X 110 X 60	238 X 76		--	FS-2
SV015iS5-4	1.5kW									
SV022iS5-4	2.2kW	FE-T012-(X)	12A	380VAC	0.5A 27A	250 X 110 X 60	238 X 76		--	FS-2
SV037iS5-4	3.7kW									
SV055iS5-4	5.5kW	FE-T030-(X)	30A	380VAC	0.5A 27A	270 X 140 X 60	258 X 106		--	FS-2
SV075iS5-4	7.5kW									
SV110iS5-4	11kW	FE-T050-(X)	50A	380VAC	0.5A 27A	270 X 140 X 90	258 X 106			FS-2
SV150iS5-4	15kW									
SV185iS5-4	18kW	FE-T060-(X)	60A	380VAC	0.5A 27A	270 X 140 X 90	258 X 106			FS-2
SV220iS5-4	22kW			70A	380VAC	0.5A 27A	350 X 180 X 90	338 X 146		
SV300iS5-4	30kW	FE-T070-2	70A	380VAC	1.3A 150A	350 X 180 X 90	338 X 146			FS-3
SV370iS5-4	37kW			70A	380VAC	1.3A 150A	350 X 180 X 90	338 X 146		
SV450iS5-4	45kW	FE-T100-2	100A	38VAC	1.3A 150A	425 X 200 X 130	408 X 166			FS-3
SV550iS5-4	55kW			120A	38VAC	1.3A 150A	425 X 200 X 130	408 X 166		
SV750iS5-4	75kW	FE-T120-2	120A	38VAC	1.3A 150A	425 X 200 X 130	408 X 166			FS-3
				170A	38VAC	1.3A 150A	480 X 200 X 160	468 X 166		

(X) (1) Industrial environment EN 50081-1 (A class)
 (2) Domestic and industrial environment EN 50081-1 (B class)

Dimensions

FF Series (Footprint)

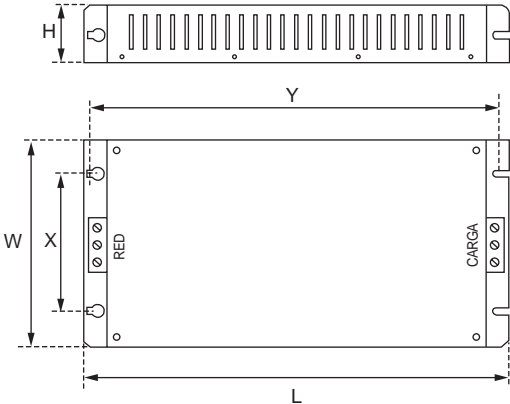

FE Series (Standard)

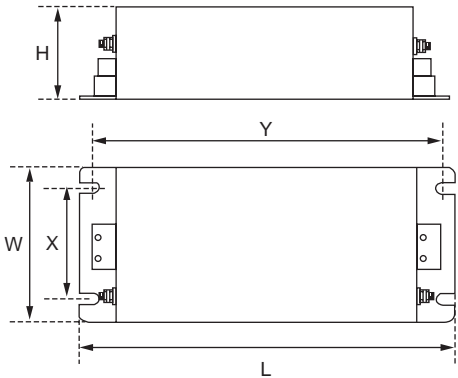

FS Series (output chokes)

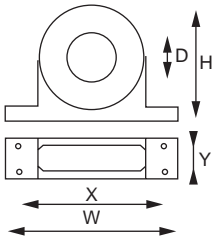

Type	D	W	H	X	O
FS-1	21	85	46	70	5
FS-2	28.5	105	62	90	5
FS-3	48	150	110	125 x 30	5
FS-4	58	200	170	180 x 45	5

RFI Filter

FF Series (Footprint)

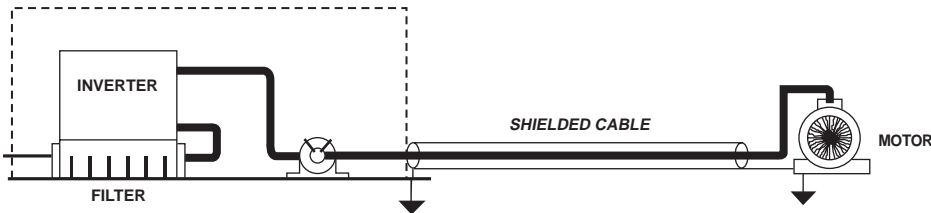

FE Series (Standard)

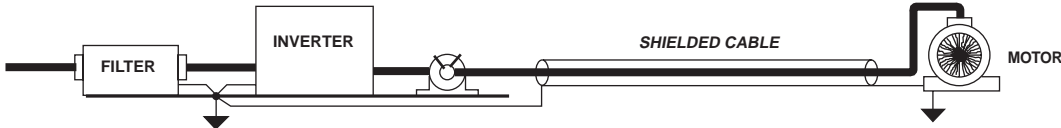



Safety Instructions

- For your safety, please read user's manual thoroughly before operating.
- Contact the nearest authorized service facility for examination, repair, or adjustment.
- Please contact qualified service technician when you need maintenance. Do not disassemble or repair by yourself!
- Any maintenance and inspection shall be performed by the personnel having expertise concerned.

2003.2 LS Industrial Systems Co.,Ltd. All rights reserved.

LS Industrial Systems Co., Ltd.

www.lsis.biz

HEAD OFFICE

LS Tower 1026-6, Hogue-dong, Dongan-gu,
Anyang-si, Gyeonggi-do 431-848, Korea

Europe	+82-2-2034-4376 / ywsohn@lsis.biz
Middle East	+82-2-2034-4901 / bonseongk@lsis.biz
South West Asia	+82-2-2034-4645 / sungkyup@lsis.biz
South East Asia	+82-2-2034-4707 / ohpark@lsis.biz
CIS	+82-2-2034-4913 / jinhkang@lsis.biz
America	+82-2-2034-4377 / younsupl@lsis.biz

Global Network

- **LS Industrial Systems (Middle East) FZE Dubai, U.A.E.**
Address: LOB 19 JAFZA VIEW TOWER Room 205, Jebel Ali Freezone P.O. Box 114216, Dubai, United Arab Emirates
Tel: 971-4-886 5360 Fax: 971-4-886-5361 e-mail: hwyim@lsis.biz
- **Dalian LS Industrial Systems Co., Ltd. Dalian, China**
Address: No.15, Liaohexi 3-Road, Economic and Technical Development zone, Dalian 116600, China
Tel: 86-411-8273-7777 Fax: 86-411-8730-7560 e-mail: lixk@lsis.com.cn
- **LS Industrial Systems (Wuxi) Co., Ltd. Wuxi, China**
Address: 102-A, National High & New Tech Industrial Development Area, Wuxi, Jiangsu, 214028, P.R.China
Tel: 86-510-8534-6666 Fax: 86-510-522-4078 e-mail: xuhg@lsis.com.cn
- **LS-VINA Industrial Systems Co., Ltd. Hanoi, Vietnam**
Address: Nguyen Khe - Dong Anh - Ha Noi - Viet Nam
Tel: 84-4-882-0222 Fax: 84-4-882-0220 e-mail: srjo@lsisvina.com
- **LS-VINA Industrial Systems Co., Ltd. Hochiminh, Vietnam**
Address: 41 Nguyen Thi Minh Khai Str. Yoco Bldg 4th Floor, Hochiminh City, Vietnam
Tel: 84-8-3822-7941 Fax: 84-8-3822-7942 e-mail: sbpark@lsisvina.com
- **LS Industrial Systems Tokyo Office Tokyo, Japan**
Address: 16FL, Higashi-Kan, Akasaka Twin Tower 17-22, 2-chome, Akasaka, Minato-ku Tokyo 107-8470, Japan
Tel: 81-3-3582-9128 Fax: 81-3-3582-2667 e-mail: jschuna@lsis.biz
- **LS Industrial Systems Shanghai Office Shanghai, China**
Address: Room E-G, 12th Floor Huamin Empire Plaza, No.726, West Yan'an Road Shanghai 200050, P.R. China
Tel: 86-21-5237-9977 (609) Fax: 89-21-5237-7191 e-mail: jinhk@lsis.com.cn
- **LS Industrial Systems Beijing Office Beijing, China**
Address: B-Tower 17FL Beijing Global Trade Center B/D. No.36, BeiSanHuanDong-Lu, DongCheng-District, Beijing 100013, P.R. China
Tel: 86-10-5825-6025,7 Fax: 86-10-5825-6026 e-mail: cuixiaorong@lsis.com.cn
- **LS Industrial Systems Guangzhou Office Guangzhou, China**
Address: Room 1403,14F, New Poly Tower, 2 Zhongshan Liu Road, Guangzhou, P.R. China
Tel: 86-20-8326-6764 Fax: 86-20-8326-6287 e-mail: linsz@lsis.biz
- **LS Industrial Systems Chengdu Office Chengdu, China**
Address: Room 1701 17Floor, huanminhanjun international Building, No1 Fuxing Road Chengdu, 610041, P.R. China
Tel: 86-28-8670-3101 Fax: 86-28-8670-3203 e-mail: yangcf@lsis.com.cn
- **LS Industrial Systems Qingdao Office Qingdao, China**
Address: 7B40, Haixin Guangchang Shenye Building B, No.9, Shandong Road Qingdao 26600, P.R. China
Tel: 86-532-8501-6568 Fax: 86-532-583-3793 e-mail: lirj@lsis.com.cn



Specifications in this catalog are subject to change without notice due to continuous product development and improvement.